

## **40 - Town of Warwick**

# Notice

---

The opinions expressed in this report do not necessarily reflect those of the New York State Energy Research and Development Authority (hereafter “NYSERDA”) or the State of New York, and reference to any specific product, service, process, or method does not constitute an implied or expressed recommendation or endorsement of it. Further, NYSERDA, the State of New York, and the contractor make no warranties or representations, expressed or implied, as to the fitness for particular purpose or merchantability of any product, apparatus, or service, or the usefulness, completeness, or accuracy of any processes, methods, or other information contained, described, disclosed, or referred to in this report. NYSERDA, the State of New York, and the contractor make no representation that the use of any product, apparatus, process, method, or other information will not infringe privately owned rights and will assume no liability for any loss, injury, or damage resulting from, or occurring in connection with, the use of information contained, described, disclosed, or referred to in this report.

NYSERDA makes every effort to provide accurate information about copyright owners and related matters in the reports we publish. Contractors are responsible for determining and satisfying copyright or other use restrictions regarding the content of reports that they write, in compliance with NYSERDA’s policies and federal law. If you are the copyright owner and believe a NYSERDA report has not properly attributed your work to you or has used it without permission, please email [print@nyserda.ny.gov](mailto:print@nyserda.ny.gov)

# NY Prize Stage 1 – Warwick Microgrid Project Final Report

*April 25, 2016  
(Revised Aug. 2, 2016)*

*Prepared For:*

NYSERDA



*Prepared By:*

Warwick Microgrid Project Technical Team



In cooperation with Project Stakeholders including the Town and Village of Warwick



## CONTENTS

Executive Summary:.....	3
<b>Section I: Microgrid Capabilities .....</b>	<b>8</b>
1.1 Minimum Required Capabilities.....	8
1.2 Preferable Microgrid Capabilities .....	21
<b>Section II Task 2: Technical Design Costs and Configuration .....</b>	<b>30</b>
2.1 Proposed Microgrid Infrastructure and Operations .....	30
2.2 Load Characterization .....	45
2.3 Distributed Energy Resources Characterization .....	55
2.4 Electrical and Thermal Infrastructure Characterization.....	70
2.5 Microgrid and Building Controls Characterization.....	73
2.6 Information Technology (IT)/Telecommunications Infrastructure Characterization .....	75
<b>Section III: Task 3: Commercial &amp; Financial Feasibility .....</b>	<b>78</b>
3.1 Commercial Viability – Customers .....	79
3.2 Commercial Viability - Value Proposition .....	86
3.3 Project team.....	94
3.4 Creating and Delivering Value.....	98
3.5 Financial viability.....	109
3.6 Legal Viability .....	113
<b>Section IV: Task 4: Benefit-Cost Analysis .....</b>	<b>118</b>
Business Model Financial Results: .....	118
Benefit-Cost Analysis Results:.....	118
<b>Lessons and Recommendations .....</b>	<b>120</b>
New York State Policy Recommendations: .....	121
Warwick Microgrid Project Recommendations: .....	122
<b>Appendix A: Warwick Microgrid Layout Diagram .....</b>	<b>124</b>
<b>Appendix B: Warwick Microgrid One-Line Diagram .....</b>	<b>125</b>
<b>Appendix C: Customer Viability Methodology .....</b>	<b>126</b>
<b>Appendix D: Optional Multi-Tiered Energy Services Model .....</b>	<b>128</b>
<b>Appendix E: Benefit-Cost Analysis.....</b>	<b>130</b>

**Warwick Microgrid Project – NY Prize Stage I  
Task 5 Deliverable: Final Report**

## Executive Summary:

This report summarizes the work of the Project Team to assess the feasibility of a community microgrid for the Town and Village of Warwick in Orange County, New York, fulfilling the deliverable requirements for NY Prize Stage I, Task 5 – “Final Written Documentation.” The report is divided into four sections, generally corresponding with Tasks 1 through 4 of the feasibility assessment process:<sup>1</sup>

- Executive Summary
- I. Capabilities and requirements
- II. Technical feasibility
- III. Business and legal feasibility
- IV. Benefit-cost analysis
- Conclusion

Section III describes a business structure whereby the microgrid would be owned and operated by a P3 entity that would arrange funding for the project. The P3 would generate revenue through energy service agreements for a 25-year period. The economics of the project were analyzed using a life-cycle cost analysis, which shows that the project has a positive net-present value (NPV) and an estimated unlevered internal rate of return (IRR) of at least 7.6% – sufficient to support an investment in this project.

Based on the estimated energy savings, assumed project financing costs, and the 25-year contract term, the team’s assessment indicates that the project can deliver electricity savings of 7% to 10% the current weighted electric rate of the key critical facilities of \$0.129/kWh.<sup>2</sup>

In consultation with the Warwick Community,<sup>3</sup> the project team identified four strategic goals for the proposed microgrid:

1. Improve the resiliency of services that are critical to the health, safety, and vitality of the community;
2. Increase the community’s use of local resilient renewable energy assets;
3. Reduce the community’s fossil energy consumption and related environmental footprint; and
4. Support future economic development and growth by modernizing community energy infrastructure.

Based on these four community goals, as well as the objectives of the NY Prize program, the project team proposed a technical solution and a business structure that would meet these goals and objectives. Specifically, Section II describes and analyzes technical designs for a multi-zone microgrid to serve multiple community critical assets. The design relies on technology systems and approaches that are either fully mature or are readily available and sufficiently demonstrated in the market today.

---

<sup>1</sup> Appended by reference are the Task 1 through 3 reports prepared during the course of the project. Also, Appendix E includes the Task 4 Benefit-Cost Analysis Summary provided by NYSERDA contractor Industrial Economics Inc. (IEc). Appended by reference are IEc’s BCA data worksheets.

<sup>2</sup> Figures updated from the project Task 3 report.

<sup>3</sup> The term “Warwick community” refers collectively to the Town of Warwick, the Village of Warwick, and other energy customers and stakeholders in and around Warwick, N.Y.

Section III describes a business structure in which the microgrid would be developed, installed, owned, and operated by a public-private partnership (P3) special purpose entity (SPE). The P3 would generate revenue through energy service agreements for a 25-year period to support project cost recovery, debt service, and investment returns. Such ownership and business structures are well understood and have been successfully applied at many analogous projects.

The project team analyzed project economics using a life-cycle cost analysis. This analysis shows that the project has a positive net-present value (NPV) and an estimated unlevered internal rate of return (IRR) of at least 7.6% – sufficient to support an investment in this project – given appropriate counterparty covenants and credit criteria.

The current weighted electric rate of the key critical facilities included in the proposed microgrid is approximately \$0.129/kWh. Based on the estimated energy savings, assumed project financing costs, and the 25-year contract term, the study supports an ESA electric rate with an electric cost that represents an average discount of approximately 7% to 10% for the facilities in this project.

The project team’s financial feasibility analysis generally agrees with IEC’s benefit-cost analysis results, which indicate that the project achieves a positive benefit-cost ratio (1.2) in the absence of any electricity outages.

The project team’s analysis differs from the IEC analysis because IEC’s standard framework for NY Prize projects included certain assumptions to allow all 83 projects to be evaluated on an equivalent basis. However, not all factors are equal across all 83 projects. For example, IEC assumed the same natural gas prices for all 83 NY Prize projects, and those prices are higher than retail natural gas prices provided by Orange & Rockland for distributed generation units in the project area. Additionally, IEC excluded the value of federal Investment Tax Credits, and it also assumed full replacement cost for all affected systems, versus the project team’s expectations that existing equipment will be retained and incorporated into new systems.

These differences, which are detailed in Section IV., yield lower costs and more benefits in the project team’s financial analysis, compared to the IEC analysis. These differences were anticipated, given the different purposes and assumptions of the two analyses. In either case, however, the proposed project presents a favorable economic case for the community in the baseline scenario, and that economic case would improve to the degree the community experiences electricity outages.

In sum, the NY Prize Stage 1 feasibility analysis indicates that the proposed Warwick Microgrid project would be a technically and economically feasible solution to address the four community goals outlined above. Moreover the proposed microgrid would establish a replicable and financeable structure for community microgrids that could be applied to other communities throughout the state of New York. Specifically, it would demonstrate a scalable and flexible public-private partnership (P3) ownership model; a multi-tiered service model that can be adapted for use in any community with similar strategic goals; a design and technology approach capable of providing resilience for critical facilities throughout a community; a financing approach that establishes standard covenants and structures capable of attracting both public and private commercial financing; and an integrated community planning approach that efficiently addresses both immediate and long-term resiliency needs.

## Background

**Project Team:** The NY Prize Stage 1 feasibility assessment has been performed by a collaborative Project Team, comprised of the technical team and the Warwick stakeholders team. Specifically, the technical team is led by Microgrid Institute, which managed collaborative efforts of its own principals as well as subcontractors Hitachi Microgrids, Green Energy Corp., and TeMix Inc. The technical team's efforts were guided by several Warwick stakeholder organizations, including the Town and Village of Warwick, the Warwick Valley Central School District, Bon Secours Charity Health System, and Sustainable Warwick. The Project Team's utility partner is Orange & Rockland Utilities. The NYSERDA Project Officer for this project is Joanna Moore.

**Methodology and Tools:** The Project Team closely followed NYSERDA's instructions in performing its analysis. Specifically, to perform Tasks 1, 2, and 3, the Team performed outreach and engagement with community stakeholders to gather information about the baseline situation, resiliency needs, and several related community objectives – most notably involving modernizing local infrastructure, supporting opportunities for economic development, increasing energy efficiency, developing local renewable energy resources, and retaining energy dollars in the community.

The Team performed an iterative analysis process that included baseline research, microgrid design modeling, system modeling, analysis, and refinement. Vital steps in the research and analysis process included:

- A) Visiting most of the facilities contemplated in the study, to gather as-built baseline data
- B) Meeting with Warwick stakeholders and the utility partner to discuss baseline and planned system configuration, usage, and requirements
- C) Obtaining customers' historic energy usage, cost, and pricing records for substantially all facilities in the study
- D) Convening weekly technical team conference calls to address Task issues, and collectively to analyze design issues and modeling outputs in support of additional research, modeling, and refinements
- E) Convening bi-weekly Project Team conference calls to update project status, address outstanding action items, and collectively analyze design issues and modeling outputs
- F) Conducting numerous additional phone calls and meetings to address questions and analyze design issues and modeling outputs

The team's efforts included two primary types of analysis:

- A) Qualitative analysis, addressing general questions regarding objectives and potential solutions; and
- B) Quantitative analysis, addressing the outputs of detailed modeling and simulation efforts to estimate system design and technical performance.

The outputs of such analysis informed iterative refinements of the proposed microgrid system design, business model and legal structure, and technical solutions specified to meet design objectives.

The Project Team performed qualitative analysis by applying to various project questions its experience and expertise with: microgrid systems, business, and regulatory models; utility distribution system technologies and practices; municipal integrated planning, development, and policy processes; and policy objectives of the State of New York generally and the Reforming the Energy Vision (REV) initiative in particular.

To allow empirical assessment of qualitative factors, the Team used Microgrid Institute's customer viability screening matrix to consider economic, technical, legal & market, and process factors, as well as

other criteria. Based on the Team’s research and engagement efforts, the customers to be served by the microgrid were assigned values for numerous viability factors, including:

- Needs and wants;
- Financial support options;
- Current energy supply arrangements;
- Credit strength;
- Thermal loads & load profiles;
- Existing infrastructure;
- Energy efficiency upgrade options;
- Siting & permitting factors;
- Local energy resources;
- Technology solution options;
- Regulation and policy context;
- Utility support for project objectives;
- Market costs for alternative services;
- Clarity of sponsor authority;
- Level of sponsor support; and
- Integration factors.

The results were unweighted for purposes of the Stage I analysis, to support baseline feasibility analysis within the NY Prize context. The outputs of this qualitative screening and analysis are described in Section III.

The technical team based its quantitative analysis on two complementary modeling efforts – one technical and one economic. These efforts were intended to effectively model the feasibility of the proposed system within an accuracy tolerance of +/-30 percent.

The team modeled the technical approach using HOMER Pro (Hybrid Optimization Model for Multiple Energy Resources). HOMER Pro is a microgrid software tool originally developed at the National Renewable Energy Laboratory (NREL), and enhanced and distributed by HOMER Energy. HOMER nests three integrated tools in one software product, allowing microgrid design and economics to be evaluated concurrently. This modeling results in performance estimates for energy generation, system costs, lifecycle costs, and operational efficiencies. The key features of HOMER Pro are:

*Simulation:* HOMER simulates the operation of a hybrid microgrid for an entire year, in time steps from one minute to one hour.

*Optimization:* HOMER examines all possible combinations of system types in a single run, and then sorts the systems according to the optimization variable of choice.

*Sensitivity Analysis:* HOMER allows the user to run models using hypothetical scenarios. The user cannot control all aspects of a system, and cannot know the importance of a particular variable or option without running hundreds or thousands of simulations and comparing the results. HOMER makes it easy to compare thousands of possibilities in a single run.

Where some or all customer energy data was unavailable, the project team estimated the energy intensity of those facilities. Where possible, the team used data from highly similar buildings in the state of New York, obtained through separate project efforts and the team members’ proprietary data libraries. Where data on highly similar buildings were not available, the team used data from the Commercial Building Energy Consumption Survey provided by the U.S. Department of Energy.



In order to model the economic performance of this system, the project team used proprietary Hitachi analysis and analytics software called EconoScope to model project costs and benefits. The tool incorporates engineering design considerations and allows for evaluation of financial sensitivities, projected financial impacts, goal-oriented scenario modeling, cash flow optimization, and cost-benefit analysis. EconoScope is intended to provide insight into the financial viability of microgrid projects and as well as evaluate the benefits to multiple stakeholders. The software was designed and is supported by a development team at Hitachi’s Matsudo Research Center in Japan, where Hitachi has developed and financed hundreds of energy projects including renewable energy, distributed generation, and microgrids.

With outputs from the proposed microgrid technical design and HOMER Pro models, EconoScope analysis provided details of potential project costs and revenue streams (including PPA rates) with greater resolution than other available tools. The EconoScope models used economic conditions the project team deemed likely given the anticipated use of a third-party energy services agreement to support project financing. The team then calculated the achievable internal rate of return with blended energy rates at or below current prices for the system off-takers.

The conclusions of the team’s qualitative and quantitative analysis efforts are documented in Sections II and III.

**Summary of Project Outcomes:**

In addition to the outputs of its qualitative and quantitative analysis efforts, the Project Team’s work yielded several top-level strategy outcomes that inform its feasibility assessment.

Assessment Outcomes	Recommendations
<p><b>Because critical community assets are widely dispersed in the Warwick geography, a single islanding system would be unable to effectively meet project objectives – e.g., to provide increased energy resilience for a full set of facilities that are critical to the health, safety, and vitality of the project community.</b></p>	<p>A multi-zone system – combining several separately islanding systems in a collectively managed portfolio – can effectively meet community resiliency objectives.<sup>4</sup></p>
<p><b>Community stakeholders consistently support the Warwick Microgrid project, enabling a sustainable implementation effort.</b></p>	<p>An integrated planning and design approach would best serve the community’s interests in interdependent and complementary goals. A dynamic microgrid strategy – implementing distributed energy solutions in phases over time – will adapt to evolving community needs to the greatest practical degree.</p>
<p><b>The community supports development of renewable and non-polluting energy resources including energy efficiency systems. The most readily available renewable energy resource in the area is solar energy, with some limited potential for geothermal heat pumping, and prospects for future biomass energy production in later phases.</b></p>	
<p><b>The NY Prize competition and the REV initiative support an innovative approach that allows the community to chart its own future path to implement its resilient-energy strategy.</b></p>	<p>A public-private partnership (P3) provides an adaptive mechanism to plan and implement the microgrid project to serve the community’s strategic energy goals.</p>

<sup>4</sup> In the proposed microgrid, each zone or “node” – which may be either a connected group of facilities or an individual facility – would be capable of operating independently in isolation from the utility grid. These zones would not be physically interconnected to each other, except insofar as they all are embedded in the Orange & Rockland distribution system.

<p><b>The proposed microgrid design and business model can produce net-positive benefit-cost values for the community, and a positive financial return for the public-private partnership that would own the system.</b></p>	<p>The project team recommends proceeding with NY Prize Stage 2 application, and continuing efforts to develop the proposed project.</p>
<p><b>The community lacks financial resources to continue with Stage 2 audit-grade engineering and economic study. Members of the Project Team are prepared to provide some cost-sharing capacity in Stage 2, but external financing support will be required in order to perform advanced development.</b></p>	

In sum, the Project Team’s assessment supports continued development of the Warwick Microgrid. The assessment indicates the project is feasible, both technically and economically, and that it establishes design and development models that are both replicable and scalable for other New York communities. The Warwick Microgrid project is an excellent candidate for NY Prize Stage 2 funding to enable advanced engineering and economic study and development in anticipation of project implementation.

## Section I: Microgrid Capabilities

The approach to microgrid architecture, design, and business operations described below incorporates lessons learned and best practices from other existing microgrid projects that the Technical Team has designed and developed (*e.g.*, Olney Town Center in Maryland). It also aims to support New York State initiatives to foster innovation and competition in energy services, including the Reforming the Energy Vision (REV) proceeding.

The Warwick microgrid design is focused on the development of an overall energy strategy that incorporates both load management and new distributed generation and energy storage resources to support the microgrid’s strategic and operational objectives. Microgrid operational objectives include improving resiliency, increasing energy efficiency, reducing environmental emissions, and reducing cost to energy users in the Warwick community. Microgrid strategic objectives include establishing an engineering and decision-support platform for continued energy resiliency improvements serving future community needs.

### 1.1 Minimum Required Capabilities

#### a. Serves Critical Facilities

The microgrid is expected to provide resilient energy services to a group of facilities with critical and vital loads in the project area, as listed below:

- Warwick Town Hall, Police, and Senior Center
- St. Anthony’s Hospital
- Mount Alverno Center & Schervier Pavilion
- Pharmacy and other commercial properties
- Alteva-Warwick Valley Telecom
- Warwick Village Hall
- Two Fire Stations (25 Church and 132 South)
- Warwick Rescue Squad

- Multiple fresh water and waste water facilities (River Street Pump, Memorial Drive Micro Filtration Station, Water Lane Water Filtration Plant, Orchard St Pumping Station, State School Rd Sewer Station)
- Department of Public Works Garage & Fuel Depot

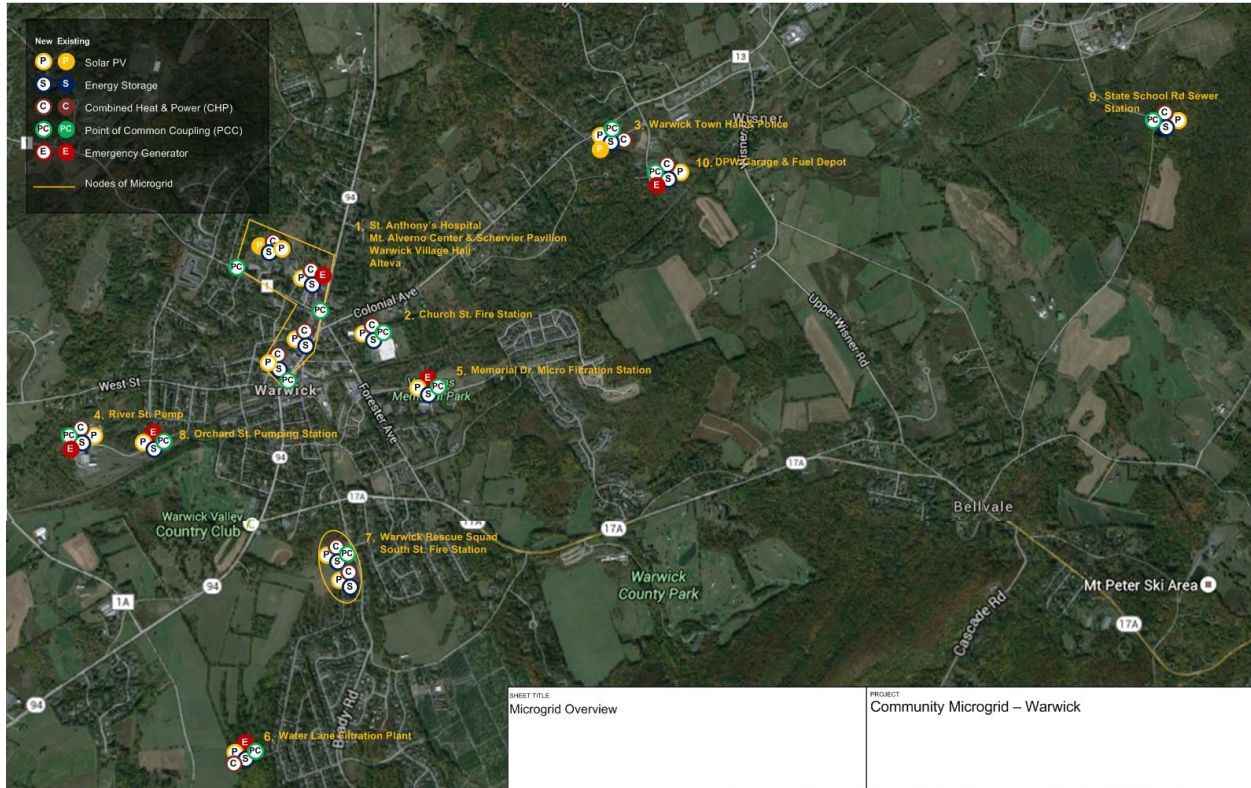

Fig. 1-A: Warwick Microgrid Overview

During the Stage 1 feasibility assessment, some substantial factors were evolving in ways that affect the Warwick Microgrid design. Final plans and designs will be reviewed and incorporated in Stage 2.

Evolving factors include the following:

- The Warwick Valley Central School District established an agreement with ConEdison Solutions to displace substantially 100 percent of the school district’s annual energy consumption with output from a non-resilient, grid-tied PV system.
- Orange & Rockland’s pre-existing proposal for a new West Warwick substation adjacent to school facilities remained pending.
- Developers planned to construct various commercial and retail facilities at the former Mid-Orange Correctional Facility (MOCF) site.

Through its stakeholder engagement and feasibility assessment efforts, the project team determined that the school district’s agreement with ConEdison Solutions locked in non-resilient resources to offset most of the school district’s electricity load, creating a substantial economic challenge to the construction of new assets required to provide resilient energy for school facilities. Additionally, Orange & Rockland’s West Warwick substation plans were insufficiently advanced to factor into the microgrid design model, preventing alternative design approaches to serve nearby school facilities. Finally, private

developers' MOCF plans were not sufficiently advanced at the current phase to serve microgrid facility modeling. As a consequence, the project team determined that the affected zones and facilities were not viable, and therefore eliminated them from the modeled microgrid. However, each of the pending developments may support microgrid expansion at some future date. Consequently, the team proposed an approach that would accommodate incremental expansions as community needs and infrastructure systems evolve. This approach also will serve to support and optimize ongoing community plans to increase energy sustainability and resilience.

#### b. Primary Generation Resources

Generation sources in the community microgrid include the following:

- Building efficiency and load control
- Solar photovoltaics (PV)
- Battery energy storage systems (ESS)
- Natural gas-fired combined heat and power (CHP) units

Section II provides detailed information about sizing and siting of generation and storage systems.

#### c. Power in Grid-Connected and Island Modes

The basis of the microgrid is a portfolio of energy resources located within 10 separate zones or node groups (see *Table II-A*). Because the microgrid project area is served almost exclusively with overhead distribution lines and service drops, the basis for resiliency would be improved by converting key segments to underground cables. The cost impact of underground cable installation is mitigated by limiting undergrounding to short distances only as required to connect major loads.

On loss of the grid, utility-controlled, remotely operated isolation switches would isolate these underground portions of the utility's circuits, leaving the microgrid to remain powered with its own distributed generators and CHP units, PV, energy storage systems, and building load control.

To maximize overall efficiencies, CHP units will be sited optimally to serve the thermal loads of larger buildings in the microgrid area. Solar PV arrays will be sited in optimal locations throughout the network, most notably on suitable rooftops, parking areas, and open land where available. Energy storage units, which are relatively small, will be sited near the solar PV resources, with a preference for indoor locations.

The layout of critical facilities in U.S. communities is typically dispersed, often served by multiple separate circuits in the power network. The Warwick project area includes three contiguous community microgrid areas with a mixture of critical and non-critical loads, served on 13.2-kV and 4.8-kV circuits from a substation in the vicinity of the microgrid's East node. Additionally Orange & Rockland has proposed a new 32 MVA substation (West Warwick Substation), but plans were not finalized during the NY Prize Stage I assessment period.

As stated above, the Warwick Microgrid is conceived as mixed-resource portfolio. The reasoning for this approach is shown below in the Team's Microgrid Portfolio Concept for financially viable microgrids (see *Fig. I-B*):

**Figure I-B: The Microgrid Portfolio Concept**

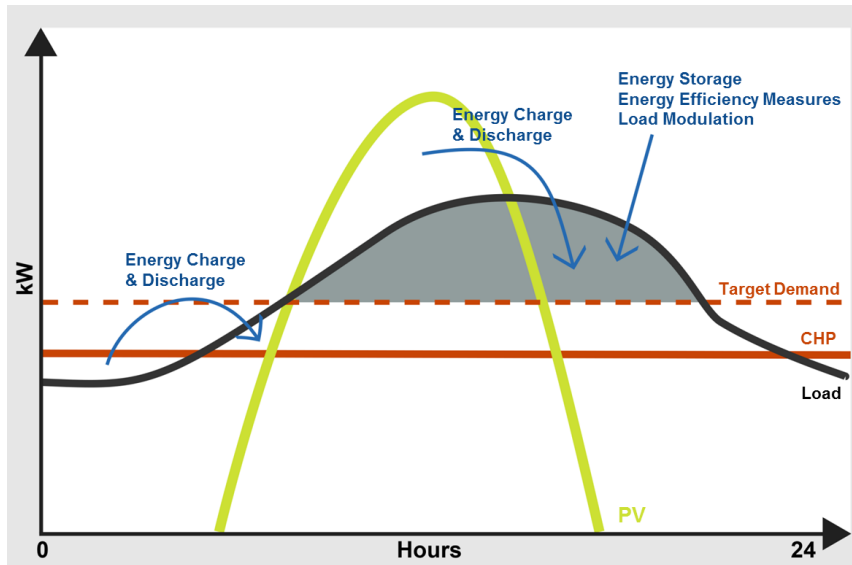

Natural gas (NG) fuel cells, microturbines, and CHP units generally are not designed to follow load. With de-rating of units, they can be used as variable resources. Using such generators in this way, however, can impair their operating efficiency and reduce their reliability and service life. It can reduce fuel efficiency and increase net emissions per unit of energy output, and maintenance costs are much higher – double or more – with sub-optimal use.

Finally, some vendors will void warranties when base-load units are used as load-following units, because de-rated operations can have negative effects on generators.

To better match the load profile, our approach is to reduce the size of the base-load generation units (CHP systems, for example) so that they run at design output for at least 8,000 hours per year.

This means that for a majority of the day, the load and CHP generation are closely coordinated. Daytime peak customer loads are better served with generation resources that have an output profile similar to the load, such as PV. Since energy storage can be designed to change its output rapidly and address ramp-rate issues, ESS can be used to follow load and to buffer the differences between CHP, electrical load, and PV throughout the day. Also, it is very important to consider the thermal load, including thermal energy storage and existing boiler operations, to ensure the resource portfolio is designed and operated to meet thermal ramping requirements as well.

From the long-term operations and maintenance standpoint, the Portfolio Concept enables the microgrid to use its resources within their design envelope. Operating units within their design parameters helps keep maintenance costs and fuel costs at their minimum, making the total cost of ownership as low as possible, supporting project economics and financing strategies.

Further, active microgrid controls enable optimal incorporation of energy efficiency measures, energy storage, PV, and building management systems to control load in such a way to reduce the afternoon peak load when needed (see Figure I-C).

**Figure I-C: Area of Interest for Active Management of Load**

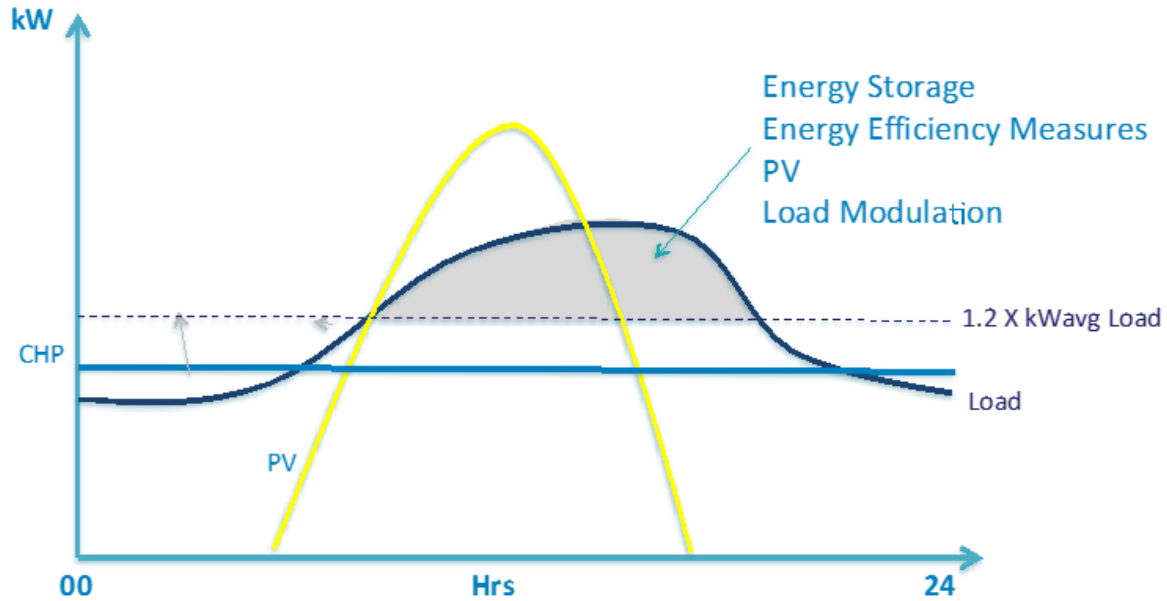

The benefit of this approach is to enable the microgrid’s resources to serve connected loads more efficiently, more cost effectively, and with lower emissions per unit of energy consumed.

As Figure I-D illustrates, critical facilities in the community reach their peak demand for only a few hours each year. This means all critical facility services can be served by the “always-on” microgrid resources for the vast majority of hours in a year without over-sizing generation capacity. In essence, the resiliency provided by the microgrid is consistent with favorable economic and emissions performance, as compared to traditional approaches where generation systems are oversized to accommodate peak loads, and where thermal and electrical needs are satisfied independently of each other. And even utility electric service is lost, the impact on critical facility services is minimized because utility power supplies represent a small portion of the energy supply to the critical facility in grid-connected mode.

**Figure I-D: Load Duration Curve**

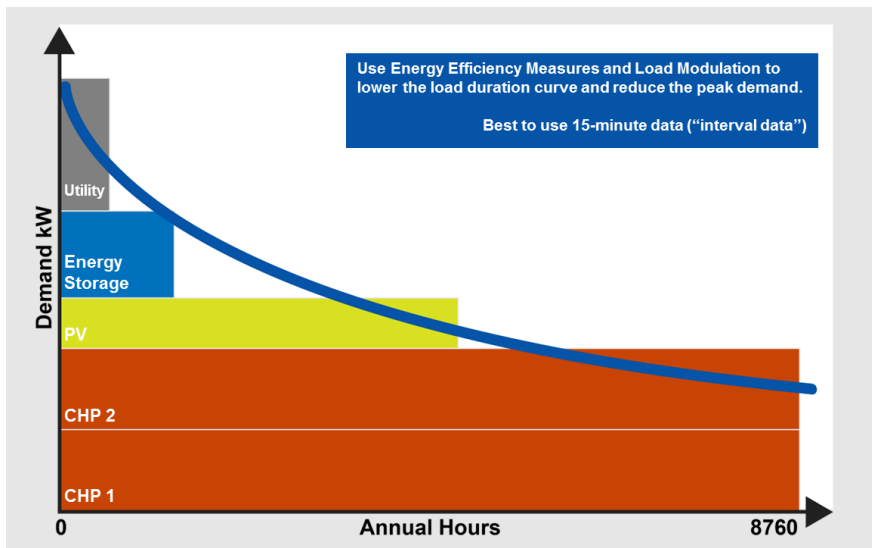

The microgrid will use a proven microgrid controller. This sophisticated active microgrid control system ensures that the microgrid's operation is being optimized for resiliency. The same software is used to manage the microgrid resources as a fleet for optimizing economics and minimizing emissions over all. The production and consumption balance of energy will be managed across the utility distribution system. The additional resiliency needed to protect the community will be available during island-mode operation of the microgrid controller. The result is improved resiliency for critical facilities and improved economics and environmental performance for the community as a whole.

In addition to this critical-facility microgrid design, the Team planned for a distributed energy overlay to serve the entire community's non-critical loads co-located with the critical loads. The plan includes sufficient distributed generation to serve the community's non-critical loads. If grid outages occur outside the community, but the community's distribution grid is unaffected, the total microgrid resources portfolio will continue to supply the needs of the non-critical loads as well as the critical facilities. If the community's distribution grid is affected, the microgrid will maintain service for facilities within the microgrid footprint, with resources prioritized for critical and vital loads. (See Section II).

#### d. Form Intentional Island

The Electric Power Research Institute (EPRI) and Oak Ridge National Laboratory collaborated on a set of ten (10) Microgrid Use Cases.<sup>5</sup> Use Case #3 – Intentional Islanding – describes the process by which a microgrid transitions from grid-connected operation to island-mode operation in a planned manner.

The islanding process for the Warwick Microgrid will be semi-automatic so that a utility operator or local energy manager will be able to apply each operating step and resiliency-preserving option before opening the point of common coupling (PCC), which is the point where the microgrid connects to the utility grid. The utility operator will provide the appropriate permissions for opening the PCC. The local controller for the microgrid will be responsible for determining the voltage source and load-following resource for transitioning to island mode.

Island-mode operation, in general, is the key to community resiliency in the face of power system disturbances, such as outages due to major storms or other emergencies. During extended events and outages, resilient energy supplies become more critical for a variety of community services, beyond police, fire, and emergency response facilities. Island operation is necessary for community resiliency in any significant outage, and especially for multi-day outages like those experienced in New York in recent years.

Through the duration of an extended power system disturbance, different services become critical to the community's health, safety, and vitality. Police, fire, and emergency medical services are critical from the beginning of a major storm or extended outage, and other services become increasingly important with time. For the first few hours of an outage, for example, a community can manage without access to fresh water, groceries, or public shelters. Within 24 hours, however, such services become necessary, and in subsequent hours and days the community develops increasingly critical needs for access to pharmacies, gas stations, banks, and places to charge mobile phones and obtain Internet service.

One microgrid design approach involves using the smallest possible amount of distributed generation and storage to meet the bare minimum of critical loads. Such an approach requires curtailing critical loads at the beginning of an outage event, and restoring critical services when and if temporary generation resources can be acquired. However, this inverted approach can complicate relief and recovery efforts, because it constrains essential services from the beginning of the event. Also, this

---

<sup>5</sup> The EPRI Microgrid Use Cases repository is available at <http://smartgrid.epri.com/Repository/Repository.aspx>

approach leaves the community dependent upon the inventory of temporary generation, which can be unreliable and inadequate; in a major event, Warwick will not be the only community seeking mobile generators, and units will be in short supply. Moreover, mobile generators burning liquid fuels can operate only until fuel supplies can be replenished, which can be challenging in the aftermath of a major weather event.

Another microgrid design approach is the Project Team’s strategy, which involves installing local generation resources sufficient to supply the critical load at its typical level at the beginning of an outage event, and then operating those resources to maintain critical services at 80 percent of normal capacity through the entire event duration. This ensures continuous energy supplies for the most critical services – police, fire, and emergency responders – and maintains basic services enabling more community residents to shelter in place rather than evacuate the area. Such an approach provides the community with a more robust and sustainable system that can sustain critical and vital functions indefinitely, and right from the beginning of an outage event.

The process of islanding a microgrid can create problematic transient power conditions and add risk to operations. To minimize this, the Project Team employs a specific design approach to interconnecting with the utility grid at the point of common coupling. Refer to Figure I-E for a description of the PCC structure.

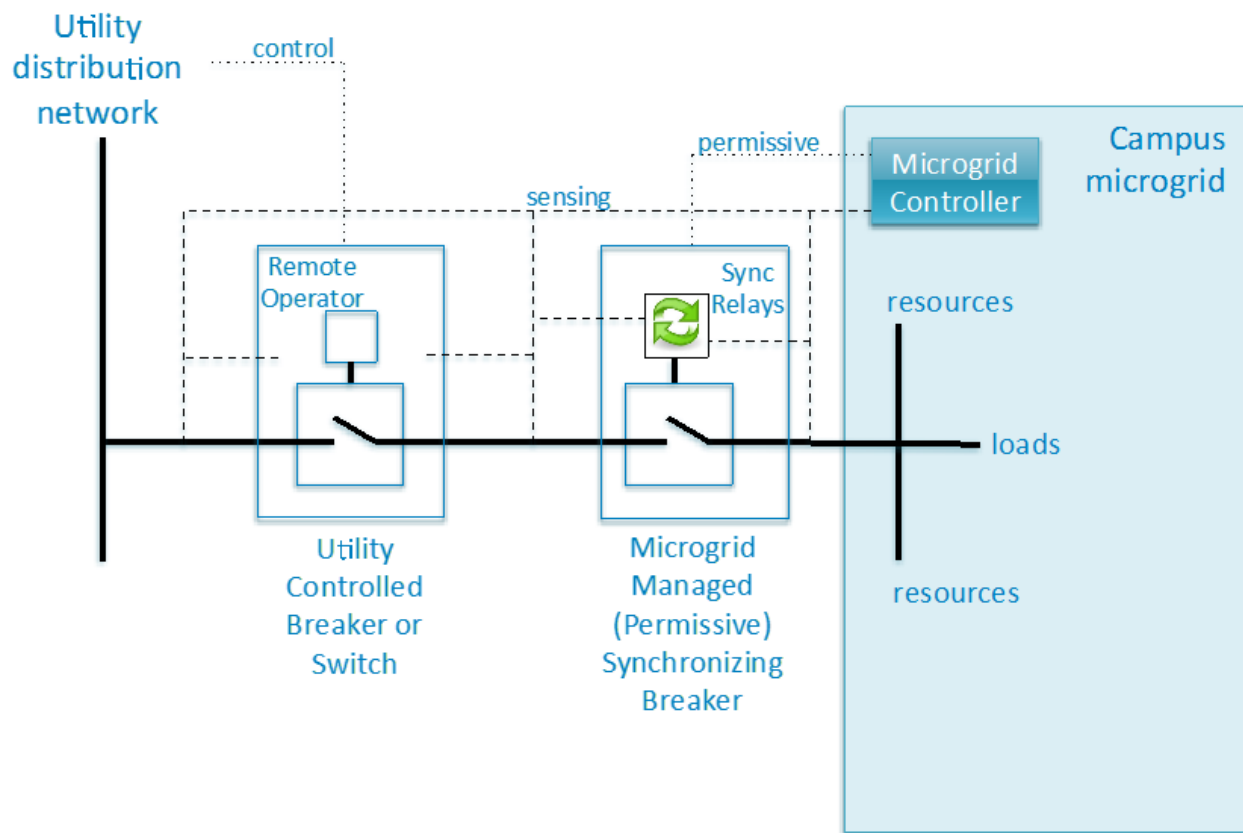

**Figure I-E: Point of Common Coupling (PCC) Structure**

This PCC structure, coupled with additional analysis compliant with IEEE 1547.4, enables the utility-controlled breaker or switch to immediately open (frequency = 59.3 Hz) on loss of the grid. The microgrid-managed synchronizing breaker will remain closed for a few more milliseconds until microgrid frequency reaches 57.0 Hz. Since the inverters and generator controls are keying off the synchronizing



breaker, these few additional milliseconds enable the energy storage and power electronics to better manage the transient as microgrid resources are dispatched to supply the portion of the load served by the utility grid just before the grid was lost. If and when the frequency dips to 57.0 Hz and the synchronizing breaker opens, the microgrid begins operating in an island mode. The microgrid controller will adjust all microgrid resources for the new state, to meet island performance objectives.

In a case where the island transition is too small to generate a transient (such as an intentional island operation), the microgrid controller will open the synchronizing breaker when voltage, frequency, and phase angle are matched and stable across the breaker.

#### e. Island from the Grid and Reconnect to the Grid

When islanding from the utility grid, several Use Cases are in action:

1. **Frequency control:** The system will monitor frequency along several thresholds – providing a discrete high-low range; the system will detect if frequency is out of range and respond by taking resources off-line or dispatching other resources to manage frequency. Also, the system will analyze data to detect subtler trends that do not exceed thresholds, but provide evidence of a possible problem.
2. **Voltage control:** In both grid-connected and islanded modes, the voltage control application will be used to provide stability to the microgrid and connected circuits.
3. **Intentional islanding:** For each microgrid node, the islanding process will be semi-automatic so that a utility operator or local energy manager will be able to step through each step before opening the PCC. The utility operator will provide the appropriate permissives for opening the PCC. The local microgrid controller for each microgrid node will be responsible for setting the voltage source and load following resource.
4. **Unintentional islanding:** For each microgrid node, the islanding process will be automatic as described above.
5. **Islanding to grid connected transition:** As with intentional islanding the utility operator will provide the appropriate permission to close in the PCC. The local microgrid controller will support the reconfiguration of each dispatchable resource.
6. **Energy management:** The microgrid controller will have corresponding applications that manage at a set of controllable generation and load assets. Within that portfolio, the system will optimize the microgrid based on load forecast, ancillary services events, changes in configuration, outage of specific equipment, or any other kind of change to determine the optimal use of assets 48 hours ahead.
7. **Microgrid protection:** The microgrid controller will ensure that each protection device is properly configured for the current state of the microgrid, either islanded or grid connected. Also, following a transition, the microgrid controller will switch settings or verify that the setting has changed appropriately. In either condition if the test is false then the controller will issue a shutdown of each resource and initiate the appropriate alarm.

More discussion on the microgrid controls can be found below in section 1.2.

The sequence of events for transitioning to an island mode is discussed above.

The sequence of events for transitioning from an island mode to grid-connected mode is formed in accordance with the EPRI/ORNL Use Case 5. The summary of the transition is as follows:

- Utility determines it is acceptable for the microgrid to reconnect to the grid and closes the utility controlled breaker (see I-D).
- Microgrid controller senses voltage, frequency, and phase angle on the bus between the utility controlled breaker and the microgrid synchronizing breaker. The controller also senses voltage, frequency, and phase angle within the microgrid.
- Microgrid controller (and/or operator) decides to reconnect the microgrid to the utility grid.
- Microgrid controller adjusts controllable resources and loads to match voltage, frequency, and phase angle across the microgrid synchronizing breaker. This minimizes differences and power flows.
- When matched, the microgrid controller give a “permissive to close” signal to the microgrid synchronizing breaker.
- The synchronizing breaker does its own checking of voltage, frequency, and phase angle matching, and closes when matched.
- The microgrid controller places some microgrid load on the utility grid, and re-optimizes for economics and emissions reduction.

#### f. Scheduled Maintenance Intervals and Utilization of Power

The scheduled maintenance for the high-efficiency natural gas engine-based CHP typically requires a quarterly routine maintenance session (< 6 hours) plus an annual routine maintenance session (< 1 week). These CHP units typically demonstrate full power operations above 8,500 hours per year.

The scheduled maintenance for the PV is an annual cleaning. The Project Team’s experience in California with PV is that solar panel surfaces foul to a 97% production level within 3 weeks of surface cleaning. Therefore, cleaning does not provide a significant difference in annual production. The annual cleaning is more about observing anything unusual in or around the installation.

The scheduled maintenance for the energy storage systems is a quarterly routine inspection of the units. The condition of the units is monitored and trended continuously during operations, which drives all maintenance based on trends in conditions. The scheduled maintenance is basically an external inspection for environmental conditions that may impact the lifetime of the energy storage systems.

The utilization of power available from the distributed energy resources (DER) in the microgrid is the primary driver for optimization. This is why the microgrid concept of operations is energy first, capacity second as described in section 1.1.c above. Energy storage becomes the most important tool in maximizing the utilization of these generating assets from addressing the inherent intermittency of solar PV to managing total microgrid power factor to 0.98.

Distributed energy storage systems (ESS) have the ability to serve many roles in a microgrid. This is why ESS is referred to as the “utility infielder” of the microgrid. Properly selected ESS can support many modes of operation:

- Constant Charge
- Constant Discharge
- Peak Shaving
- Load Smoothing
- PV Intermittency
- Load Shifting
- VAr Control
- Voltage Support
- Frequency Support

- Demand Response
- Arbitrage
- Island (voltage source)

The fundamental principle behind the technology is its capability to provide real or reactive power whether it is charging or discharging. Figure I-F shows how a community energy storage (CES) unit operates effectively in all four quadrants when commanded to do so.

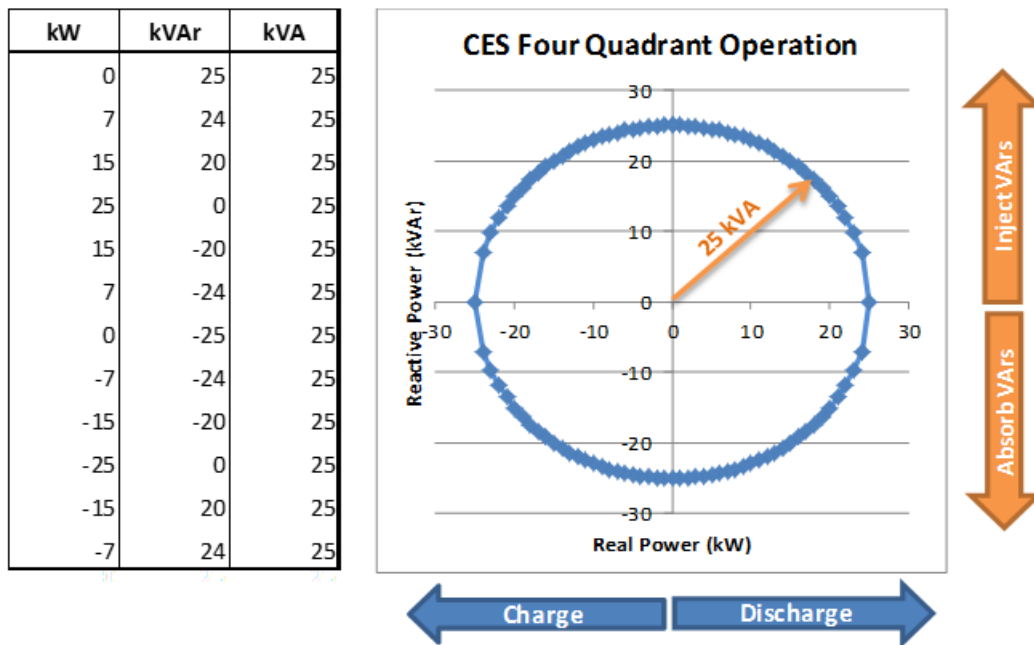

**Figure I-F: ESS Four Quadrant Operations**

This data is from Green Energy Corp actual testing of a CES unit operating in a community in San Diego.

g. Follow Load and Maintain the Voltage and Frequency

The microgrid design focused on the development of an overall energy strategy that incorporates both demand-side management and new distributed generation resources to support the microgrid operational objectives. During operation in the grid-connected mode, the resources will typically be dispatched in an economic optimization mode. This approach will ensure that the microgrid will operate in a manner that the energy delivered to the critical facilities is at or lower than that the cost of electricity that could be purchased from the local utility. In this scenario, the CHP will operate in a constant output mode at its maximum efficiency and lowest emissions, the PV generation profile will be taken into account, the energy storage will operate in a manner to maximize microgrid benefits and the grid will operate in a load following mode. The connection to the grid will also be used to manage the voltage and frequency of the microgrid.

One of the key elements of the microgrid is the ability to operate when the utility grid is not available. The methods of transitioning into an island mode are characterized as either a planned transition or an unplanned transition. In the planned transition, outside information is used to ramp up resources so that there is zero import at the point of common coupling to the microgrid and then to seamlessly transition into island operations at the appropriate time. For the microgrid project, the design requirement will be to size and operate the microgrid resources in island operation for a minimum

period of 7 days with a multi-week operation likely. During island mode operation, the microgrid control system must ensure that there is a balance of generation and load in order to maintain system stability including voltage and frequency. To accomplish this, the microgrid controller must be able to provide a load forecast of the critical load, forecast PV generation, and then dispatch resources to match the load.

It is anticipated that the resources available to be controlled during the island operations include CHP, fossil fuel generators, PV systems, energy storage, and building load. The microgrid controller will monitor island mode frequency and voltage and adjust equipment operation accordingly to maintain circuit stability. The other key element is the transition back to the grid when the utility service is restored. The design will ensure that the return to the grid is a seamless transition and is coordinated with the utility through appropriate protocols, safety mechanisms, and switching plans that will be communicated to the microgrid controller by the utility distribution management system.

To support steady-state frequency requirements, as well as the ANSI 84.1-2006 standard voltage requirements, and to support the customer power quality requirements at PCC, the microgrid controller will actively manage the dispatch of generation resources; actively manage the charge and discharge of energy storage; provide observability of microgrid wide telemetry including frequency, power factor, voltage, currents and harmonics; provide active load management; and provide advance volt-VAR variability algorithms and other stability algorithms based on steady state telemetry of the system.

#### h. Two-Way Communication and Control

Communication within the microgrid and external hosted systems requires the use of wired and wireless solutions. Communication types can be classified as both data and control paths. The microgrid controller is agnostic of the communication media and provide a level of data-in-motion security between field devices and external systems. At minimum, two-way communication to support control functions is used. A more flexible communication method is the use of a publish-subscribe middleware system to support one-to-many communications. The communication bandwidth supports dozens of devices communicating every 1 to 10 seconds. In special cases, high frequency measurements, as many as 60 samples per second, can be used for stability applications. In this case the network is tuned to support this requirement.

Controls are essential in this type of system requiring analog outputs (AO), direct operate (DO), and select-before-operate (SBO) over a reliable messaging layer. Resource levels controls occur as fast as every second for certain periods of time.

An advanced control concept is employed as distributed control logic, also referred to as machine-to-machine communication. This is dependent on the microgrid controller, middleware, and the configuration of the network.

#### i. Power a Diverse Group of Customers with Critical Facilities

As discussed above, the Warwick Microgrid will be designed to serve a group of critical facilities, plus additional non-critical facilities. This mix includes government facilities (Village and Town), public safety and infrastructure, school district, private healthcare and assisted living, and private business interests. In addition to critical facilities, the microgrid footprint includes other essential services, including pharmacies, banks, lodging, and gas stations.

The benefits of the Warwick Microgrid extend not only to local agencies and businesses, but also to residents in the greater Warwick area. During times of extended grid outages and major storms, when public safety and health services are needed throughout such events, continuously powering those facilities is essential. As the grid outage extends into the second day and beyond, additional services become critical, such as shelter, food, prescription medicines, and fuel.

#### j. Uninterruptible Fuel Supply

By converting the 13.2- and 4.8-kV class distribution circuits, the basis for resiliency would be improved for the microgrid. This microgrid underground cable is further made resilient by installing utility-controlled remotely-operated isolation switches that can isolate this portion of the circuit on loss of the grid, leaving the microgrid to remain powered with its own distributed CHP, PV, energy storage systems, and building load control.

The microgrid resource portfolio will have natural gas-based generators and CHP units, solar PV, energy storage, and building load control. In future expansion phases, biofuels also may be integrated into the project's resource portfolio. Use of biofuels will depend on fuel-supply maturity, resource availability, and economic and reliability drivers.

The feasibility assessment also will consider the potential use of ground-source heat pumps for heating and cooling. This would reduce the natural gas load in the community, which could enable use of natural gas for the CHP or further reduce the risk of loss of natural gas supply during a major storm.

Also, the use of existing emergency diesel generators will be minimized by the microgrid's operation. Therefore, the typical three-day onsite fuel load for emergency diesel generators will be extended to one week.

#### k. Demonstrate Resilience to Forces of Nature

The industry tends to talk about reliability and resiliency in terms of system average interruption duration index (SAIDI), customer average interruption duration index (CAIDI), and system average interruption frequency index (SAIFI). The IEEE 1366 reliability index of SAIDI (system average interruption duration index) is a transmission and distribution (T&D) network-level index that specifically precludes storm outages. The IEEE 1366 consensus standard considers outages due to storms to be outside the utility's responsibility to prevent. The range of utility distribution network SAIDI and CAIDI in the US is between 60 and 200 minutes (national average ~ 120) per customer per non-storm outage. The outage numbers with storms included is much higher.

Therefore, the SAIDI measure is not really consistent with the concept of community resiliency, since SAIDI does not measure resiliency to storms. The IEEE 1366 measures are network focused.

In contrast, the reliability measures used in the data center industry are much more centered on the end-user reliability. The data center industry's Uptime Institute provides much information about designing highly resilient customer (data center) systems. Uptime is defined as serving the mission, and downtime is defined as not serving the mission.

The point is that resiliency is a customer-facing objective and the metrics to demonstrate resiliency should be customer-facing as well.

According to the New York State 2012 Electric Reliability Performance Report, the NYSEG SAIFI = 0.98 interruptions/customer/year and CAIDI = 2.00 hours each outage/customer/year. These metrics exclude storm-related outages in accordance with the IEEE 1366 standard. This is roughly equivalent to the national average for non-storm related grid outages. From separate studies, the national average storm-related CAIDI is 6.67 hours each outage/customer/year; a first approximation for the storm-related resiliency in Orange County.

The feasibility assessment evaluated community-specific quality and reliability issues for both electric and gas distribution. The microgrid design is customer-facing resiliency, thus looking to uptime of the customer / critical facilities and their ability to achieve their mission.

The Warwick Microgrid design is a direct attempt to address facility-specific uptime in the face of major storms, *i.e.*, resiliency. The Team will design the microgrid to use DER structures (base foundations, enclosures, and connections) for distributed generators, fuel cells, microturbines, outdoor energy storage, solar PV panels (hail rated) and racking, and electrical distribution equipment to withstand the forces of nature described below. (Note: The Team prefers to install energy storage systems inside interior building electrical or mechanical rooms wherever possible.)

1. Wind / Tornado – Category F2 wind speeds for most areas of the U.S., and F3 for some historical high-risk areas (e.g., “tornado alleys”).
2. Rain / Flooding / Hurricane – Category 4 Hurricane (Staffer-Simpson scale, same maximum wind speed as the Category F2 tornado on the Fujita scale). In addition, the height of the base foundation for outdoor units is designed to assure the equipment is 1 to 1.5 feet above the 100-year flood plain level.
3. Earthquake – Seismic event magnitude 6.9 (Richter scale), or 100-year local seismic event, whichever is lesser. We also give due consideration in the design to overhead risk from buildings and other structures located above the microgrid equipment.
4. Heat / Derecho – 125 degrees F (50 degrees C) continuous operating temperatures. Where equipment enclosure temperatures are expected to exceed these temperatures for more than 10 minutes, space cooling is added.
5. Cold / Ice – 15 degrees F (-24 degrees C) continuous operating temperatures. Where equipment enclosure temperatures are expected to exceed these temperatures for more than 10 minutes, space heating is added. Enclosure design includes mitigation of ice formations that block air flow.

#### I. Provide Black Start

The Project Team employs the Black Start use case from EPRI/ORNL:

***Black start:*** *The local microgrid controller will provide a workflow process for restarting the system. Each microgrid node will have a unique sequence of operations for predetermined use cases. One objective will be to provide this function both locally and remotely to meet the reliability requirements of the overall design.*

Our microgrid solution has multiple black-start sources. The existing emergency generators at several locations have black-start capabilities, and automatically start on loss of the distribution grid.

In addition, each of the distributed energy storage systems within the microgrid is voltage source (normal mode) or current source (selectable). These units act as black-start capable units within 50 milliseconds of loss of voltage at the distribution grid.

In addition, the natural gas engine-based CHP units can be purchased as black-start capable.

Our scheme leads with the energy storage units in the case where a black-start would normally be required. As such, the energy storage units will serve as the first voltage source for all other equipment. For defense in depth, the emergency diesels and the CHP have the ability to serve as voltage sources for all equipment.

## 1.2 Preferable Microgrid Capabilities

### 1. Integrate and Demonstrate Operation of Advanced, Innovative Technologies in Design and Operation

The Project Team employs the microgrid EPRI/ORNL Use Cases (*see section 1.1-e*). These generic use cases provide the Team with a starting point for tailoring the use cases to the community's microgrid controls situation. Another use case on Security was added because a community resiliency microgrid represents a high-value target requiring a secure system of operations.

- **Frequency control:** In normal operations, the microgrid may not have enough resources to affect frequency on the grid. It could participate in the ancillary services markets by increasing output to support the frequency in the local grid, but total impact would be small. Nevertheless, the system will monitor frequency along several thresholds – providing a discrete high-low range; the system will detect if frequency is out of range and respond by taking resources off-line, or dispatch other resources to manage frequency. Also, the system will analyze data to detect subtler trends that do not exceed thresholds, but provide evidence of a possible problem.
- **Voltage control:** In both grid connected and islanded modes the voltage control application will be used to provide stability to the microgrid and connected circuits. Voltage control leverages line sensing and metering to provide control actions when necessary. The application will take into account traditional volt/VAr instruments such as tap changers and cap banks along with inverter-based resources, which should provide a greater degree of optimization.
- **Intentional islanding:** For each microgrid node, the islanding process will be semi-automatic so that a utility operator or local energy manager will be able to step through each step before opening the PCC. The utility operator will provide the appropriate permissions for opening the PCC. The local microgrid controller for each microgrid node will be responsible for setting the voltage source and load following resource.
- **Unintentional islanding:** For each microgrid node, the islanding process will be automatic as described in section 1.1.d above.
- **Islanding to grid connected transition:** As with intentional islanding the utility operator will provide the appropriate permission to close in the PCC. The local microgrid controller will support the reconfiguration of each dispatchable resource.
- **Energy management:** The most complex Use Case. Design incorporates a portfolio of resources. The EPRI Use Case takes a traditional energy management approach – economic dispatch, short-term dispatch, optimal power flow, and other processes typical in utility control room environments. The microgrid controller will have corresponding applications that manage at a set of controllable generation and load assets. Within that portfolio, the system will optimize the microgrid based on load forecast, ancillary services events, changes in configuration, outage of specific equipment, or any other kind of change to determine the optimal use of assets 48 hours ahead.
- **Microgrid protection:** The microgrid controller will ensure two primary conditions. The first is that each protection device is properly configured for the current state of the microgrid, either islanded or grid connected. The second condition is that after a transition the microgrid controller will switch setting or verify that the setting has changed appropriately. In either condition if the test is false then the controller will initiate a shutdown of each resource and give the appropriate alarm.

- **Ancillary services:** The primary point of this use case is to provide fleet control of the nested microgrid parts. Specifically, the utility operation will have the ability to request and or schedule balance up and balance down objectives for the fleet. The cloud-based controller will take the responsibility to parcel out the objectives for each microgrid part based on the available capacity for wholesale ancillary services benefits and potentially retail ancillary services benefits that may emerge in the future.
- **Black start:** The local microgrid controller will provide a workflow process for restarting the system. Each microgrid part will have a unique sequence of operations for predetermined use cases. One objective will be to provide this function both locally and remotely to meet the reliability requirements of the overall design.
- **User interface and data management:** The solution provides local controllers in each microgrid part as well as a hosted controller that can operate each microgrid part separately or collectively. The primary actors are the utility operator, local energy managers, maintenance personnel, and analyst. The user experience for each actor will be guided by a rich dashboard for primary function in the system around Operations, Stability, Ancillary Services, and Administration.
- **Security:** – The solution will demonstrate a trustful design and integration. This will include the following:
  - a. show how human and machine actors are authenticated and authorized,
  - b. show how data in motion is protected,
  - c. show how data at rest is managed, and
  - d. show how system monitoring is accomplished

Domain data will be used to provide simple event processing for anomaly detection and a threat model of the system will be in place to help analyze suspect operations.

From a customer perspective, an emergency generator serves 4 or 5 of these Use Cases, the utility grid serves 5 or 6 of these Use Cases, but the microgrid serves all 11 Use Cases.

The fundamental drivers for the microgrid are creating a resilient energy supply for critical facilities, while at the same time creating better economics and reducing the emissions footprint. With active control, new distributed energy technologies, and the coordinated signals to drive decisions, multi-objective functions can be performed.

#### a. Active Network Control System

One of the challenges of community microgrids is that the facilities and the microgrid resources are distributed. To maximize the economics, reliability and emissions reduction potential of the community microgrid, the microgrid controller architecture must have the capability to coordinate and control groups of resources as well as provide control for localized operations. Figure I-G below presents the project concept for the community microgrid controller.



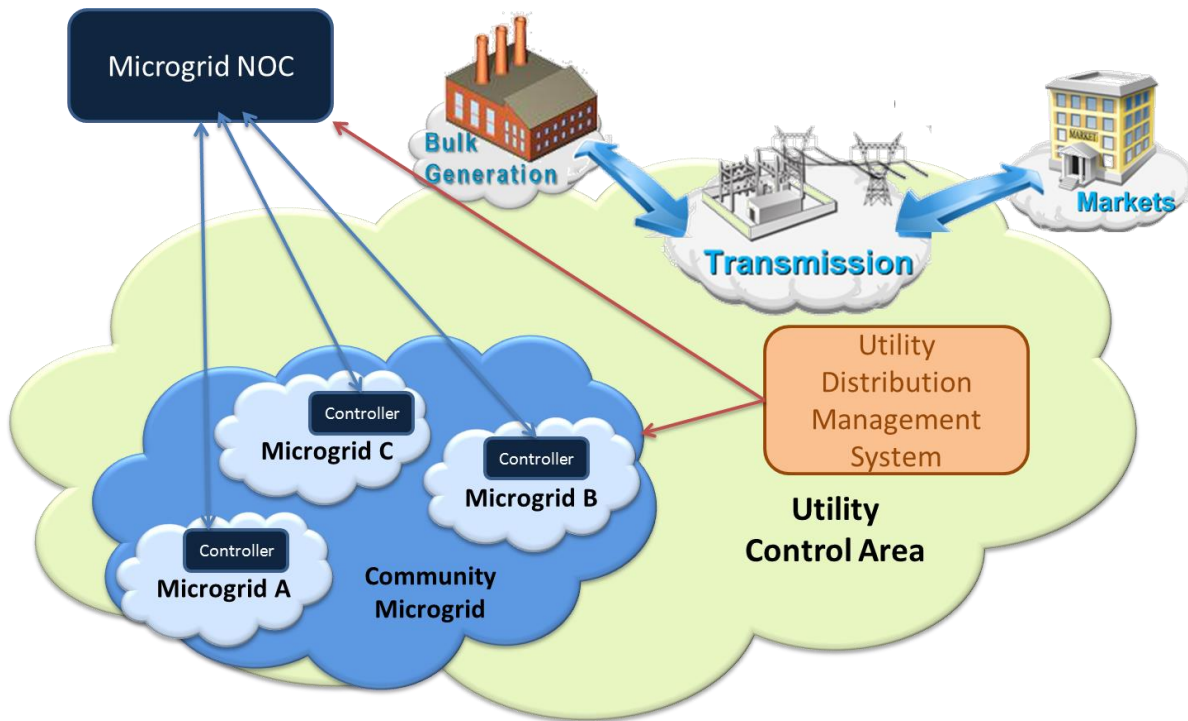

**Figure I-G: Project Concept for Community Microgrid**

This approach provides for control of multiple microgrids in the community as well as coordination with the local utility. In the grid-connected mode, the primary operations will focus on maximizing economic benefits and minimizing emissions, which is similar across all the microgrids within the community. In some cases, the aggregation of the microgrid resources can be leveraged to support utility firming request and/or RTO/ISO ancillary services such as demand response and frequency regulation. During a reliability event, the operation of each microgrid controller is focused on the load and generation assets within its control. The local controller will transition to island mode while maintaining proper voltage and frequency.

The anticipated microgrid controller will be based on a microgrid control system that allows low latency messaging and secure transport to communicate with clients on field devices, the microgrid data center and the utility distribution management system.

**b. Energy Efficiency Options**

For energy efficiency, the project team’s philosophy is “Lead with Energy Efficiency.” Energy efficiency options are deployed first to reduce the total energy load, before sizing the microgrid’s distributed energy resources. This avoids the need to over-size generation and storage systems, and thereby minimizes total project cost.

Section II addresses energy performance improvement opportunities included in the microgrid design. The final engineered system would be based on a six-step process covering detailed data collection, analysis, on-site evaluations, technology retrofit selection, installation, and operation.

*Data Collection* – The Team worked with the facilities considered in this feasibility assessment to collect such energy information as:

- Energy Consumption: Twelve months of utility usage data
- Drawings: Mechanical and Electrical

- Lighting: Number, type, wattage, and controls
- HVAC: Number, type, nameplate, horsepower, vintage, and controls
- Energy Management System: type and sequence of operation
- Refrigeration Units: Number, type, nameplate, controls
- Refrigeration Cases: Number, type of doors, type of lighting, condition of seals and gaskets
- Operations: Store hours of operation identifying open, close, maintenance, and stocking schedules

*Data Analysis* – The information collected was used to identify any trends in energy use intensity across time, geography, or technologies employed.

*On-Site Evaluations* – Findings of the data analysis were used to determine high and low performers across the portfolio. The team identified the facilities with the highest and with the lowest normalized energy intensity to perform on-site energy audits. The findings of these audits will be used when incorporating energy efficiency improvements into the microgrid project.

*Technology Retrofit Recommendations* – The team used information from the three previous steps to estimate energy efficiency retrofits for the critical facilities. The team focused on identifying measures that can be deployed across the entire portfolio and that have a payback of less than five years. Areas of focus included (but were not necessarily limited to): lighting, HVAC, controls, and refrigeration efficiency.

*Installation* – The team incorporated estimated energy efficiency potential into the microgrid design. In actual deployment, procurement and installation of energy efficiency measures would be coordinated with the microgrid installation. Because some energy efficiency measures may be deployed in non-critical facilities, installation activities would be planned and performed to ensure minimal impact on commercial operations and customers.

*Operation* – The microgrid Team modeled the prospective energy efficiency measures to ensure proper operation in concert with the microgrid. As part of the microgrid control system, energy usage will be continuously monitored. This will provide a tool to validate the energy savings realized by the portfolio of energy efficiency measures installed at each facility. Facilities that are not meeting the energy savings goals will be re-evaluated to identify and correct the short fall in energy savings.

c. Installation, Operations, Maintenance, and Communications for the System to be Interconnected

Microgrid assets and operations are expected to be financed and managed by a P3 SPE. The SPE will be accountable for the execution of all tasks associated with project development, finance, construction, ownership, and operation. The SPE will engage a Plan-Design-Build Team to perform planning, design, development, financing, and construction. An Engineering, Procurement, and Construction (EPC) Team will be responsible for final engineering as well as procurement and installation of major equipment, civil engineering, and network system integration and security for microgrid controls and communications. The Finance Team will arrange and manage all structuring and funding for project development, construction, commissioning, and integration; the Operations and Maintenance Team will manage and maintain all physical microgrid systems; and the Energy Services Team will arrange and manage all energy transactions and services.

Functional relationships and processes for this structure are illustrated in Fig. I-H.

**Figure I-H: Special Purpose Entity – Functional Diagram**

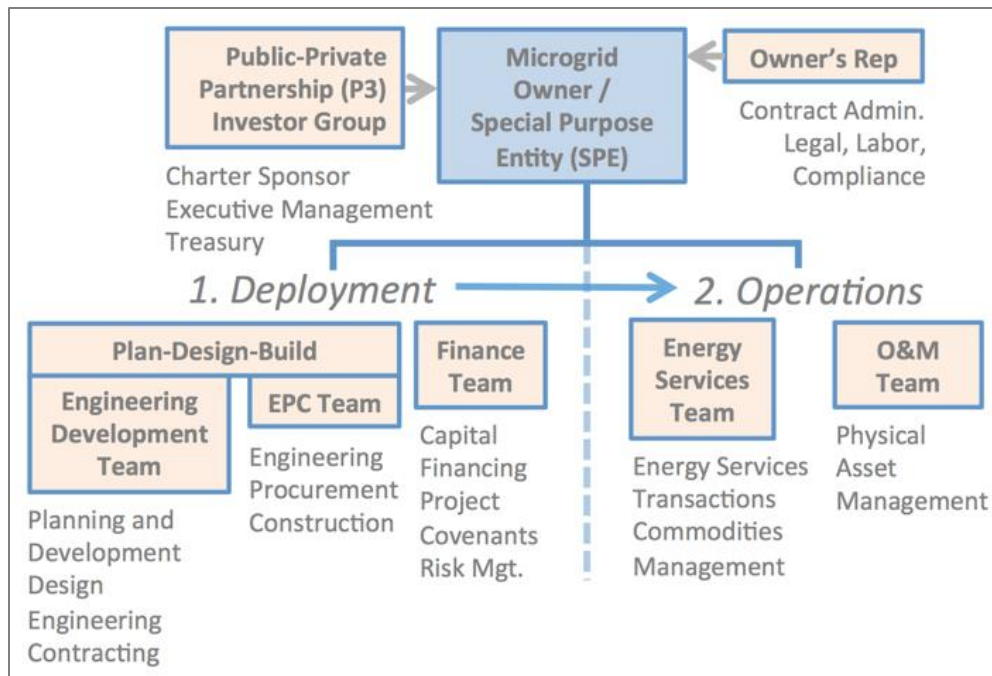

To ensure proper operation of the individual microgrid resources, the EPC contractor will conduct site acceptance tests that validate the operation and performance of the new equipment. Once the system construction and integration are complete, the SPE will engage a third-party commissioning agent that will test the microgrid as a system to ensure that the controls, communication and sequence of operation function to meet the requirements as defined in the use cases and the final design.

After the fully commissioned system is accepted and transferred to the SPE, the SPE will own and operate the microgrid for a contracted period – prospectively 25 years. The operation will leverage the autonomous functionality of the microgrid controller and minimize the need for on-site operators. The controller will operate the microgrid in a manner to maximize safety and security, economic and environmental benefits, and reliability of service in the event of a fault on the grid. In addition, the microgrid controller will monitor the performance, operation, and alarms of the distributed resources. In the event of an alarm, the SPE will be notified through the NOC and dispatch a service technician that will be engaged through a service contract. The microgrid controller will also track the hours of operation of each microgrid resource and will employ a predictive maintenance strategy to schedule maintenance before a failure and at a time period that will be the least impactful to the overall operation of the microgrid.

d. Coordinate with REV Process – Platform for Innovative Services

1) *Microgrid and REV Objectives*: Key objectives of the proposed microgrid include modernizing local grid infrastructure and establishing a platform for development and operation of innovative and competitive energy assets and resources. These microgrid objectives are consistent with the objectives of New York’s Reforming the Energy Vision (REV). Achieving these objectives will involve two primary processes:

- a. Enabling safe and reliable dispatch of distributed resources within the community microgrid service area through:
  - i. Physical reconfiguration and upgrades of local distribution systems (including installing buried cable to connect some nodes)

- ii. Deployment of distributed data acquisition and control systems
- b. Enabling economic dispatch of microgrid energy and capacity resources (including customer loads), primarily through:
  - i. Deployment of resource management and information management applications (microgrid controls)
  - ii. Establishment of counterparty contracting and clearing mechanisms supporting deployment and operation of distributed energy assets.

2) *Platform for Energy Development*: A successful community microgrid will establish an engineering and economic platform that supports efficient ongoing development and investments in local energy assets, and provides incentives for operation of assets to achieve optimal outcomes consistent with microgrid objectives – e.g., improved local resilience, energy self-reliance, environmental performance, and financial economics. Specifically, the proposed microgrid would establish a physical platform for various entities to install, integrate, and operate DG, ESS, and demand-side management systems (DSM) – as well as an economic platform for dispatching resources and managing economic transactions among counterparties within the microgrid service area.

- a. Resilient Energy Services: The Warwick Microgrid energy services model will provide resilient electricity services for facilities identified as critical for the safety, health, and vitality of the Warwick community.
- b. Enhanced Value for Distributed Resources: The Warwick Microgrid will enhance the value of resilient energy investments in several important ways.
  - i. Optimized capital deployment: Ensures investments in local distributed energy resources (including generation, storage, and demand management) improve community resiliency, by establishing locational deployment priorities and interconnection options that are optimized for microgrid operations.
  - ii. Streamlined clean energy investments: Establishes market-based transaction and contracting frameworks to simplify private investments and facilitate increasingly cost-efficient, timely, and replicable deployment of local energy assets.
  - iii. Aggregated purchasing power: Provides Warwick customers with the opportunity to obtain resilient energy assets and services at reduced costs.
- c. Investigating Micro-Market Potential: The project team investigated the potential of establishing a micro-market for buying and selling energy resources in the Warwick community and driving real-time economic dispatch of microgrid resources. The Project Team considered options for establishing a local market for long-term contracting and short-term trading of energy resources. In such a transactive energy (TE) micro-market, resource supply, demand, and engineering conditions would produce dynamic price signals to drive long-term asset investments and energy-use responses. Section III addresses TE micro-market implications for the project design.

#### e. Comprehensive Benefit-Cost Analysis

In addition to producing data inputs for the NY Prize cost-benefit model and analysis, the project team performed an independent analysis of project economics (*see Sections III and IV*). This analysis allowed the project team to optimize the design and will complement the modeling effort by the NYSERDA cost-benefit model consultant.

#### f. Leverage Maximum Private Capital

The Team evaluated multiple options to determine the most effective ownership structure for the microgrid. The Team believes the best structure will be a public-private community development entity with shared ownership between public agencies and private entities, including individuals and companies, both for-profit and not-for-profit owners.

In addition to ensuring strong community involvement in executive and treasury decisions affecting the community microgrid, this P3 ownership structure provides the greatest possible flexibility for capital financing. This flexibility will allow access to the lowest-cost sources of both debt and equity funds for each layer of the project's capital stack – including development financing, construction financing, and long-term financing.

As described in c. above, the vehicle for structuring the public-private development will be an SPE (or more than one SPE) designed to serve the specific needs of the project and its stakeholders and partners (See Figure I-1). Careful planning, legal review, and negotiations will be required for various scenarios. For example:

- A. Microgrid assets behind the meter on public/government facilities – the SPE may be co-owned by the public/government authority, a special non-profit funding agency, and/or third-party investors
- B. Microgrid assets behind the meter on private facilities – the SPE may be co-owned by third-party investors, local economic development agency, community group, and/or utility (likely a non-regulated business unit)
- C. Microgrid assets behind the meter on private facilities – the SPE could be owned by third-party investors alone
- D. Microgrid assets above the meter – the SPE may be co-owned by the public/government authority, a special non-profit funding agency, the utility, and/or third-party investors
- E. Microgrid assets above the meter – the utility, customers, or third-party investors could be sole owners

Private capital can be accessed effectively through each of the five options A through E. For example, tax credits and depreciation benefits can allow access to equity capital from private investors that carry qualifying tax liabilities. Public owners can access tax-exempt public capital sources, potentially including municipal bonds and federally insured public infrastructure development funds. And public entities with taxing authority can facilitate access to Property Assessed Clean Energy (PACE) funds for qualifying energy improvements. Each type of financing may contribute to a cost-effective capital financing strategy for the project.

In option A, the special non-profit funding agency is an IRS tax-exempt entity that uses private capital for passive taxation offsets, and the third-party investors are private capital firms.

In option B, the third-party investors are private capital firms, and the utility affiliate will utilize private capital for its ownership share.

In option C, the third-party investors are private capital firms.

In option D, the special non-profit funding agency is an IRS tax-exempt entity that uses private capital for passive taxation offsets. The utility will utilize private capital for its ownership share, and the third-party investors are private capital firms.

In option E, the utility will utilize private capital.

In any of these scenarios, the utility will continue to own and operate its existing electric distribution systems throughout the community. New microgrid assets – including generation, storage, demand

management, and interconnection and distribution systems – may be owned by any combination or variation on the ownership structures described above.

g. Clean Power Resources

As discussed in the section on the microgrid portfolio of resources and the goal of reduced emissions, clean and renewable resources are key elements of our design approach. The primary types of clean power resources that are considered for this microgrid design, at this stage of the project, are solar PV and biofuels. PV serves as a resource with a generation profile similar to the electric load of the microgrid (afternoon peak). Consequently, although PV generates electricity only during the day and output can vary on cloudy days, PV complements other microgrid resources and adds the benefit of having no fuel cost and very low maintenance cost, supporting the microgrid’s operational economics. In the Team’s experience in designing microgrids, PV can provide cost-effectively provide approximately 20 percent of a microgrid’s annual energy consumption.

The team evaluated other renewable energy resources and found limited opportunities in the Warwick area (*see Sections II and III*). For example, review of wind resources in the Warwick area indicates that wind generation will not be viable in this microgrid design. Biomass fuels are insufficient at the scale necessary for reliable local energy production, notwithstanding potential future regional biomass fuel production initiatives. Ground-source geothermal heat pumps may offer opportunities at some locations. Additionally, some potential may exist for micro-hydro generation deployed at a reservoir serving the Warwick municipal water system.

h. Demonstrate Tangible Community Benefits

The Warwick Microgrid will provide the community with opportunities to hedge against increasing energy rates, with the continuous operation of on-site generation resources. The microgrid also will provide improved power quality to customers that have sensitive electronic equipment and systems requiring uninterrupted electric service, and thereby will reduce production losses.

Microgrid resiliency benefits extend beyond customers within the microgrid footprint to nearby residents in Warwick and Orange County. During times of extended grid outages and major storms, when public safety and health services are needed throughout such events, continuously powering those facilities is essential. As the grid outage extends into the second day and beyond, additional services become critical, such as shelter, food, healthcare, prescription medicines, banking, and fuel.

2. Incorporate Innovation that Strengthens the Surrounding Grid and Increases Actionable Information Available to Customers

The proposed Warwick Microgrid will strengthen the local electricity system in several key ways. Most notably, the energy resources installed in Warwick will reduce local dependence on long-distance power transmission lines. Utility-controlled remotely operated isolation switches will allow the local distribution company to manage islanding microgrid systems to support local grid stability. Additionally, in key locations it will convert 13.2- and 4.8-kV overhead lines and service drops for critical assets to underground cables, reducing vulnerability to storms and other physical assaults that cause outages and power quality issues.

Among the key objectives of the Warwick Microgrid, the Team considered options for enabling economic dispatch of local energy and capacity resources, including customer loads. A platform for such economic dispatch would include two key solution sets:

- a. Resource management and information management applications allowing direct control of local generation, storage, and demand resources

- b. Counterparty contracting and clearing mechanisms supporting deployment and economic dispatch of distributed energy assets

Section III addresses the team’s assessment of how the Warwick Microgrid could demonstrate a TE micro-market approach to economic dispatch.

## Section II

### Task 2: Technical Design Costs and Configuration

Summary: Section II describes the preliminary assessment of the technical design and system configuration for the proposed Warwick Microgrid. The Warwick Microgrid design is focused on the development of an overall energy strategy that incorporates both load management and new distributed generation and energy storage resources to support the microgrid’s strategic and operational objectives. These objectives include improved resiliency, increased energy efficiency, reduced environmental emissions, and reduced energy cost for customers in the Warwick community.

This section is organized in accordance with the sub tasks outlined for Task #2 in the NY Prize Stage I Feasibility Assessment statement of work.

#### 2.1 Proposed Microgrid Infrastructure and Operations

##### *Microgrid Layout*

The Warwick Microgrid is expected to provide resilient energy services to a group of facilities with energy loads that are critical to the health, safety, and vitality of the project area. These include a hospital, command center, emergency response facilities, water and wastewater systems, and commercial facilities that are important to the region during extended grid outages and the emergencies that often accompany them. The microgrid also includes state and local government (both Town and Village of Warwick), public safety, private non-profit healthcare, and private for-profit business interests.

The Warwick Microgrid will support the resiliency of other vital services that will directly or indirectly benefit all 6,700 residents of the Village of Warwick, and many of the 32,000 residents of the Town of Warwick.

The proposed community microgrid will cover three major areas in Warwick – West, Central, and East – as well as additional satellite locations designed to incorporate remote critical facilities into the microgrid. Collectively, a total of 10 nodes comprise the Warwick microgrid (*see Table II-A*).

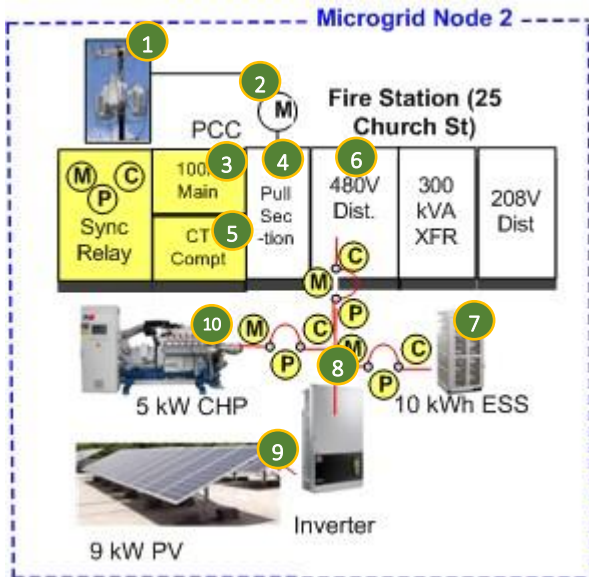

**Table II-A – Overview of Microgrid Nodes**

Microgrid Node #	Facilities	Functions
1	<ul style="list-style-type: none"> <li>• St. Anthony’s Hospital</li> <li>• Mount Alverno Center &amp; Schervier Pavilion</li> <li>• Alteva-Warwick Valley Telecom</li> <li>• Multiple Commercial Properties</li> <li>• Warwick Village Hall</li> </ul>	<ul style="list-style-type: none"> <li>• Medical services</li> <li>• Telecommunications</li> <li>• Municipal offices and services</li> <li>• Community services including food, banking, and gas</li> </ul>
2	<ul style="list-style-type: none"> <li>• Fire Station (25 Church)</li> </ul>	<ul style="list-style-type: none"> <li>• Fire and emergency response</li> </ul>
3	<ul style="list-style-type: none"> <li>• Warwick Town Hall and Police</li> </ul>	<ul style="list-style-type: none"> <li>• Government services</li> <li>• Police response</li> </ul>
4	<ul style="list-style-type: none"> <li>• River Street Pump</li> </ul>	<ul style="list-style-type: none"> <li>• Water treatment</li> </ul>
5	<ul style="list-style-type: none"> <li>• Memorial Drive Micro Filtration Station</li> </ul>	<ul style="list-style-type: none"> <li>• Water treatment</li> </ul>
6	<ul style="list-style-type: none"> <li>• Water Lane Water Filtration Plant</li> </ul>	<ul style="list-style-type: none"> <li>• Water treatment</li> </ul>
7	<ul style="list-style-type: none"> <li>• Warwick Rescue Squad</li> <li>• Warwick Fire Station (132 South)</li> </ul>	<ul style="list-style-type: none"> <li>• Fire and emergency response</li> </ul>
8	<ul style="list-style-type: none"> <li>• Orchard St Pumping Station</li> </ul>	<ul style="list-style-type: none"> <li>• Water treatment</li> </ul>
9	<ul style="list-style-type: none"> <li>• State School Rd Sewer Station</li> </ul>	<ul style="list-style-type: none"> <li>• Water treatment</li> </ul>
10	<ul style="list-style-type: none"> <li>• DPW Garage &amp; Fuel Depot</li> </ul>	<ul style="list-style-type: none"> <li>• Government maintenance</li> <li>• Government vehicle fuel</li> </ul>

Appendix A provides complete layout of the design showing all microgrid nodes. This geospatial image shows the facilities and location of electrical infrastructure and major new microgrid resources. More details about each individual node are presented in the node overviews that follow. In addition, a microgrid one-line diagram is presented in Appendix B. The diagram includes the substation, major electrical equipment, and the rated capacity for each microgrid distributed energy resource. The points of common coupling (PCC) are shown with associated monitoring (M), control (C), and protection (P) devices.

**Figure 2-A: One-Line Diagram Explanation**



1. Transformer to the critical facility
2. Utility meter
3. Synchronizing relay controls / main breaker (100A) with monitoring, protection relays and controls
4. Main disconnect (pull section)
5. Instrument current transformer compartment
6. Main 480V 3-phase distribution panel; step-down transformer and 208V 1-phase distribution panel
7. Energy storage system (ESS) with M, C, P
8. New 480V 3-phase cable (red)
9. Solar PV array and associated inverter
10. Combined Heat & Power (CHP)

The following pages highlight the layout design and one-line diagram subsection for each node as well as a brief explanation of included energy resources.

## Geospatial Diagrams and One-Line Subsections

### Node 1 Overview

#### Geospatial Diagram

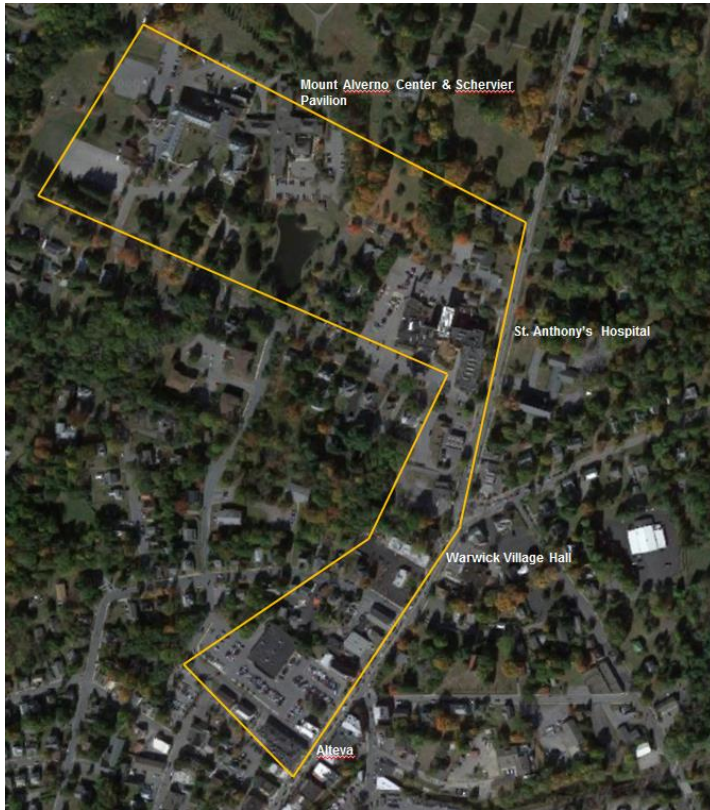

#### Description

Node 1 is the largest node in the microgrid and includes St. Anthony's Hospital, Mt. Alverno Center & Schervier Pavilion, Warwick Village Hall, and Alteva – Warwick Valley Telecom.

In addition, Node 1 includes all businesses on the west side of Main Street between Warwick Village Hall and Alteva. This includes multiple restaurants, a bank, and retail stores such as a pharmacy and auto parts store.

Node 1 includes many new energy generation and storage resources. The placement and capacity of these resources at key facilities is described in the section-by-section breakdowns that follow.

## Node 1 System Configuration- North

### Geospatial Diagram

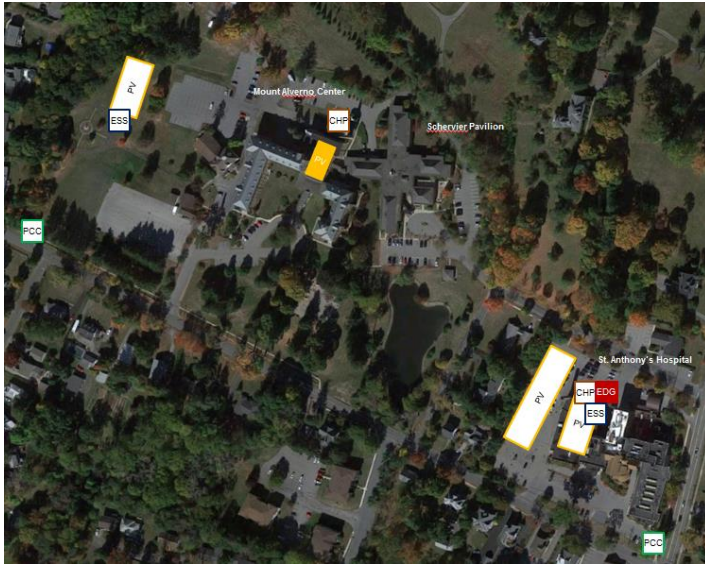

### One-Line Diagram

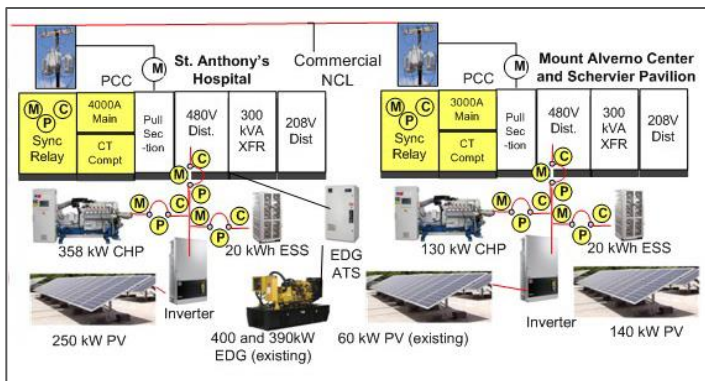

### Key Facilities

- St. Anthony's Hospital
- Mt. Alverno Center & Schervier Pavilion

### Description

The North section of Node 1 includes an existing 60 kW PV system at the Mt. Alverno Center (represented in solid orange in the geospatial diagram) and two emergency diesel generators (400 kW and 390 kW) at St. Anthony's Hospital. Two PCCs will exist – one to the west of the node and the other to the southeast.

As part of the microgrid, the following will be installed:

- **PV (140 kW):** A ground-mounted PV system will be located on the west side of the Mt. Alverno Center.
- **PV (250 kW):** A PV system will be located at St. Anthony's Hospital. Roof space was limited, so one array will be a PV rooftop while the other will be a PV covered parking structure.
- **CHP (130 kW):** A CHP system will be placed behind the Mt. Alverno Center at the facility with existing PV.
- **CHP (358 kW):** A CHP system will be placed near the PV covered parking structure in the parking lot of the Hospital.
- **ESS (20 kWh):** An ESS unit will be placed near the new PV system to the west side of the Mt. Alverno Center building.
- **ESS (20 kWh):** An ESS unit will be placed near the CHP unit in the parking lot of the Hospital.

## Node 1 System Configuration- South

### Geospatial Diagram



### One-Line Diagram

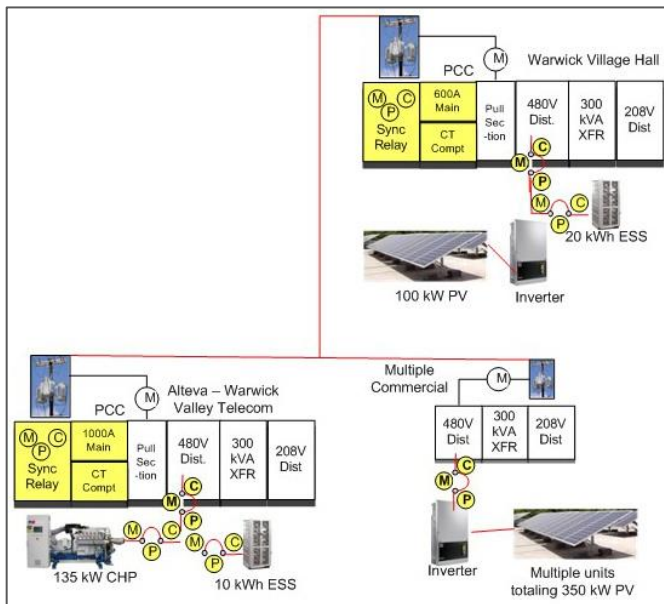

### Key Facilities

- Warwick Village Hall
- Alteva – Warwick Valley Telecom
- Multiple commercial facilities located in a complex between Village Hall and Alteva, including a pharmacy and an ATM.

### Description

The South section of Node 1 includes two critical facilities to support town governance and community communications systems. There will be one PCC at the south edge of the node. A new underground circuit will be installed to pick up the commercial customers in between Village Hall and Alteva.

As part of the microgrid, the following will be installed:

- **PV (100 kW):** A rooftop PV system will be installed on the Village Hall.
- **PV (350 kW):** Multiple PV units totaling 350 kW will be installed at building complexes located in between the Village Hall and Alteva, which includes multiple commercial facilities.
- **CHP (135 kW):** A large CHP system will be placed in the back of the Alteva building.
- **ESS (20 kWh):** An ESS unit will be placed near the CHP unit at the Village Hall.
- **ESS (10 kWh):** An ESS unit will be placed near the CHP unit at the Alteva building.

## Node 2 System Configuration

### Geospatial Diagram

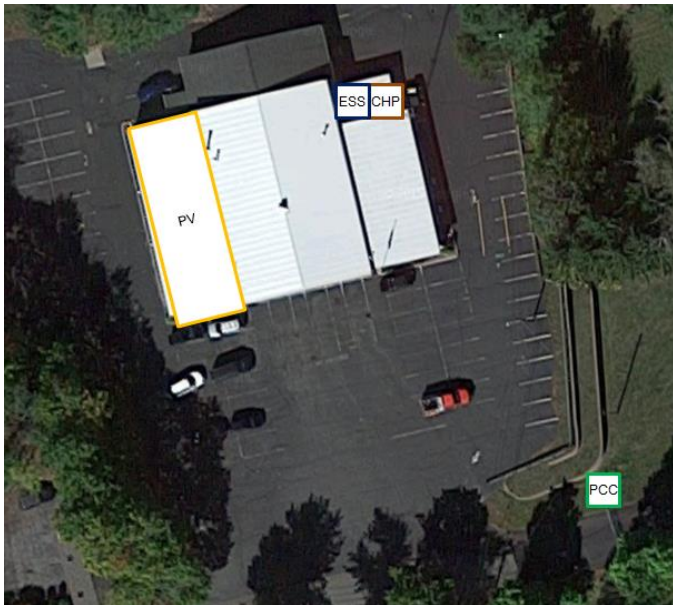

### One-Line Diagram

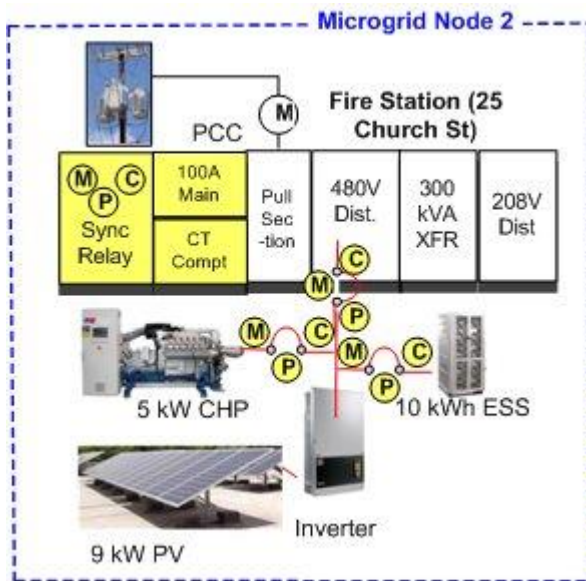

### Facility

- Church St. Fire Station

### Description

Node 2 is a single facility node.

As part of the microgrid, the following will be installed:

- **PV (9 kW):** A small rooftop PV system will cover the west side of the roof.
- **CHP (5 kW):** A small CHP system will be placed in the northeast corner of the building.
- **ESS (10 kWh):** A small ESS unit will be placed near the CHP system.

### Node 3 System Configuration

#### Geospatial Diagram



#### One-Line Diagram

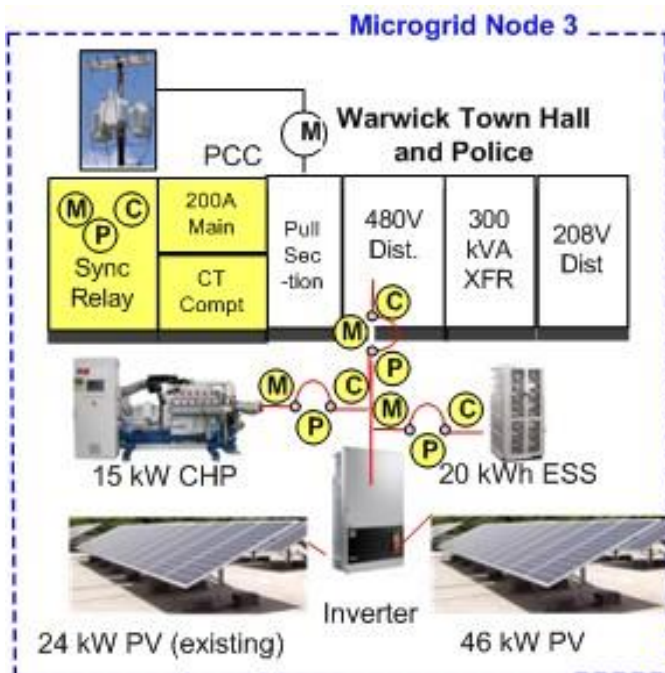

#### Facility

- Warwick Town Hall
- Police Station
- Senior Center/Public Shelter

#### Description

Node 3 includes one facility. It includes an existing 24 kW PV system (represented in solid orange in the geospatial image). The PCC will be located near the main road in front of the facility.

As part of the microgrid, the following will be installed:

- **PV (46 kW):** A new rooftop PV system will cover part of the senior center roof.
- **CHP (15 kW):** A small CHP system will be placed at the back of the building.
- **ESS (20 kWh):** A small ESS unit will be placed at the back of the building next to new CHP system.

## Node 4 System Configuration

### Geospatial Diagram



### One-Line Diagram

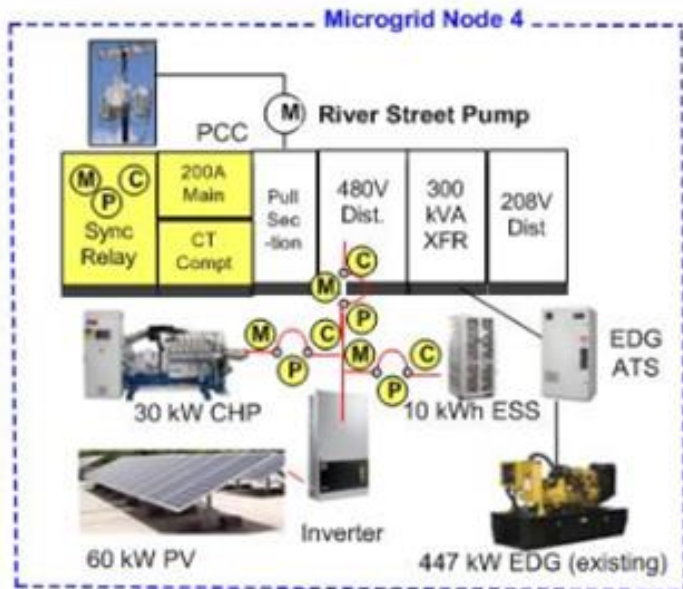

### Facility

- River St. Pump

### Description

Node 4 is a single facility node with a combination of roof and ground-mount PV. It includes an existing 447 kW emergency diesel generator. The PCC will be located to the southern edge of the property.

As part of the microgrid, the following will be installed:

- **PV (60 kW):** There will be combination ground and roof PV.
- **CHP (30 kW):** A CHP system will be placed near the existing backup generator.
- **ESS (10 kWh):** An ESS unit will be placed indoors.



## Node 5 System Configuration

### Geospatial Diagram



### One-Line Diagram

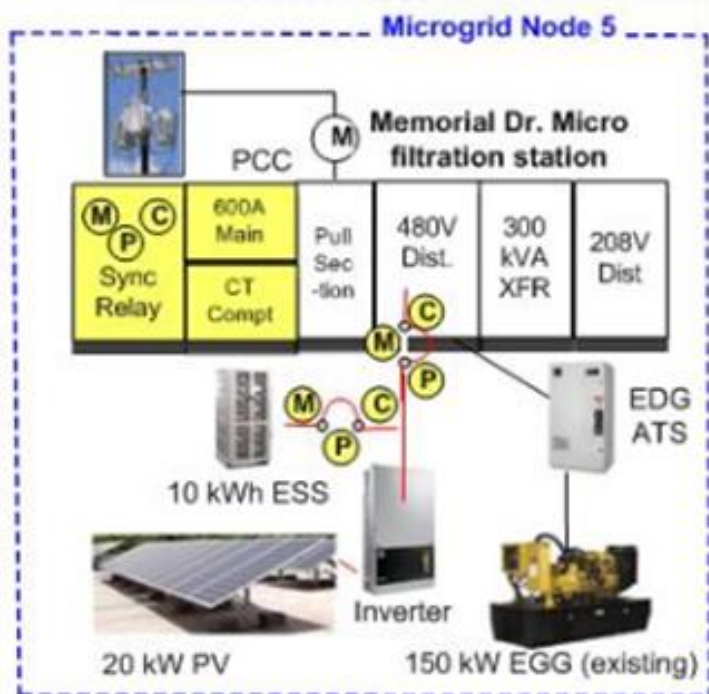

### Facility

- Memorial Drive Micro Filtration Station

### Description

Node 5 is a single facility node. It includes an existing 150 kW emergency gas generator. The PCC will be at the northwest edge of the property.

As part of the microgrid, the following will be installed:

- **PV (20 kW):** There will be a rooftop PV system.
- **ESS (10 kWh):** An ESS unit will be placed inside the building.

## Node 6 System Configuration

### Geospatial Diagram



### One-Line Diagram

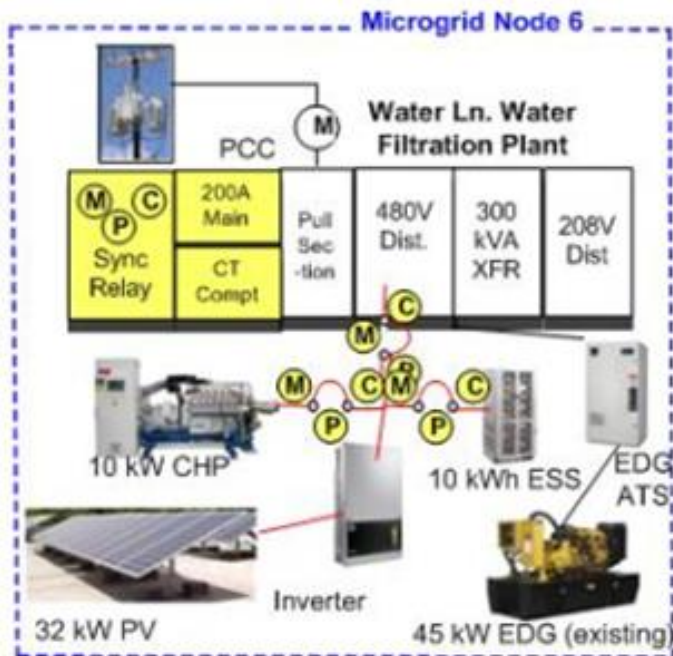

### Facility

- Water Ln Water Filtration Plant

### Description

Node 6 is a single facility node. It includes an existing 45 kW emergency diesel generator. The PCC will be at the western edge of the property.

As part of the microgrid, the following will be installed:

- **PV (32 kW):** A PV system will be mounted on the roof.
- **CHP (10 kW):** A CHP system will be placed near the existing backup generator.
- **ESS (10 kWh):** An ESS unit will be placed inside the building.

## Node 7 System Configuration

### Geospatial Diagram



### One-Line Diagram

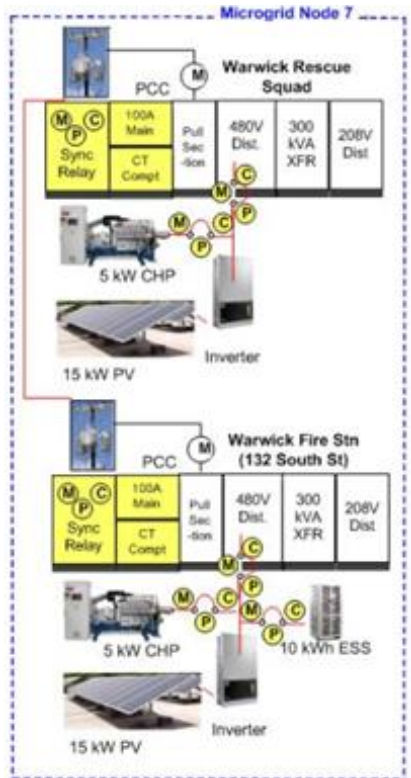

### Facility

- Warwick Rescue Squad
- Warwick Fire Station (132 South St)

### Description

Node 7 is a two facility node. The two PCCs will be at the northern end of the Warwick Rescue Squad property and the southern end of the Warwick Fire station property.

As part of the microgrid, the following will be installed:

### Warwick Fire Station

- **PV (15 kW):** A rooftop PV system will be located on the roof of the fire station.
- **CHP (5 kW):** A CHP system will be placed outside the fire station.
- **ESS (10 kWh):** An ESS unit will be placed inside the fire station.

### Warwick Rescue Squad

- **PV (15 kW):** A rooftop PV system will be located on the roof of the Rescue Squad building.
- **CHP (5 kW):** A CHP system will be placed outside the Rescue Squad building.

## Node 8 System Configuration

### Geospatial Diagram



### Facility

- Orchard St Pumping Station

### Description

Node 8 is a one facility node. There is an existing 90 kW emergency gas generator.

As part of the microgrid, the following will be installed:

- PV (24 kW):** A ground mounted PV system will be located to the north of the building.
- ESS (10 kWh):** An ESS system will be placed inside near the existing backup generator.

### One-Line Diagram

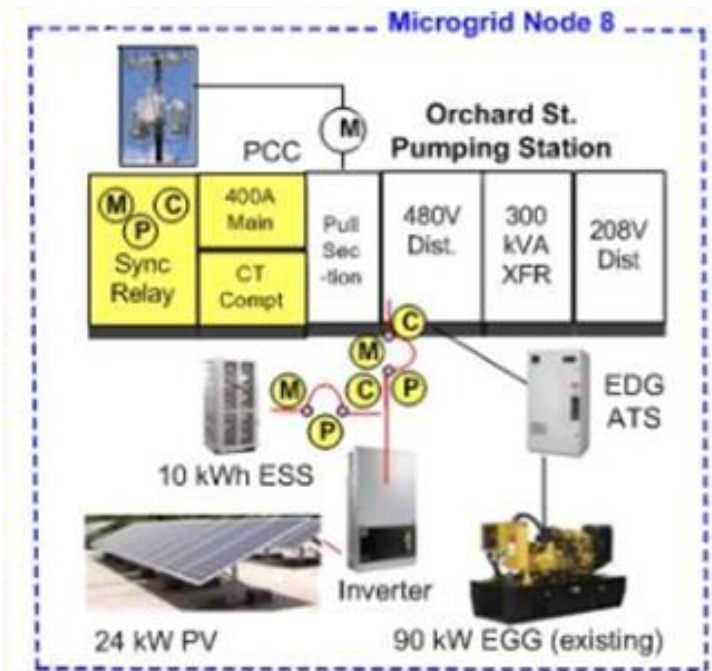

## Node 9 System Configuration

### Geospatial Diagram



### One-Line Diagram

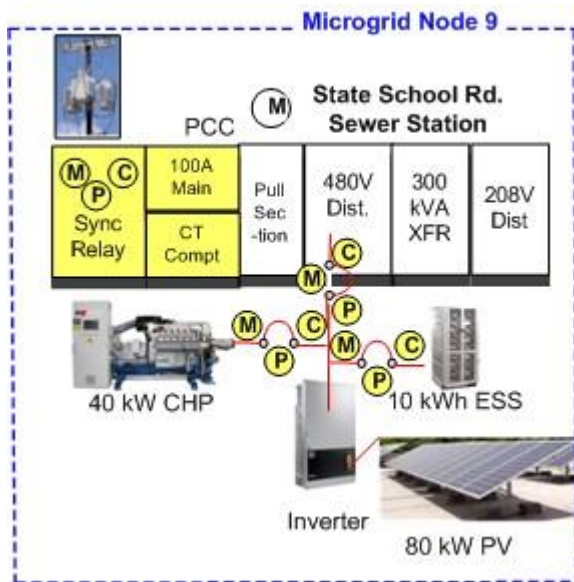

### Facility

- State School Rd. Sewer Station

### Description

Node 9 is a single facility node. The PCC will be at the northwest edge of the property.

As part of the microgrid, the following will be installed:

- **PV (80 kW):** A rooftop PV system will be located on the garage structure behind the main building.
- **CHP (40 kW):** A small CHP system will be placed inside the building. There is limited parking and property space for this unit on the ground.
- **ESS (10 kWh):** An ESS unit will be placed near the CHP system inside the building.

*Note:* Sections II and III include discussion of future economic development in the vicinity of the nearby former Mid-Orange Correctional Facility. The Task 2 design omitted consideration of uncertain prospective energy loads at the MOCF site, but future expansion potential was included among factors affecting node design.

## Node 10 System Configuration

### Geospatial Diagram



### One-Line Diagram

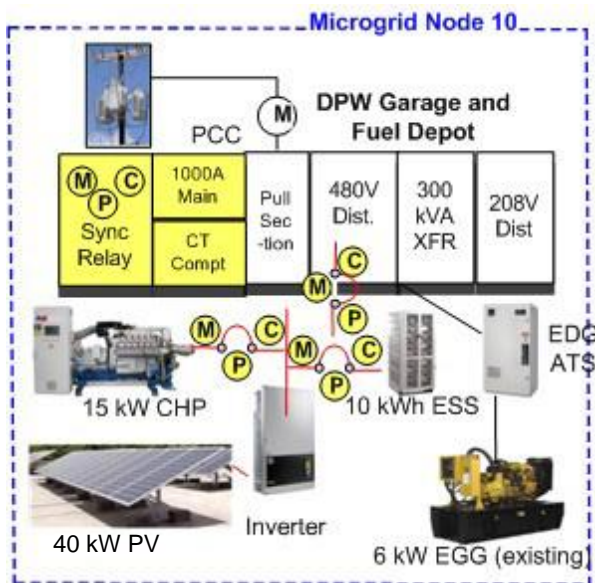

### Facility

- DPW Garage and Fuel Depot

### Description

Node 10 is a single facility node. An existing portable 6 kW emergency diesel generator is stored on site. The PCC will be at the northwest edge of the property.

As part of the microgrid, the following will be installed:

- **PV (40 kW):** A rooftop PV system will cover half of the roof.
- **CHP (15 kW):** A small CHP system will be placed inside the facility.
- **ESS (10 kWh):** An ESS unit will be placed inside the facility near the CHP system.

*Note:* The design team evaluated potential for combining Node 3 (Town Hall+Police) and Node 10 (DPW Garage) into a single node, but determined that any potential DER sizing benefits would be minimal and the cost of underground cabling between the two nearby facilities was not justified. Future development in the vicinity could support a larger integrated node in this area in the future.

## Normal and Emergency Operations

As described in Section I, the microgrid DER selection is based on a microgrid portfolio approach that focuses on energy requirements and a close match to the electric load profile of all covered facilities (see Fig. I-B). One of the most important attributes of the Warwick community microgrid will be the ability to operate when the utility grid is not available. The methods of transitioning into an island mode are characterized as either a (1) planned transition or (2) unplanned transition.

- **Planned Transition:** In a planned transition, outside information is used to ramp up resources so there is zero grid import to the microgrid. A seamless transition occurs into island operations at the appropriate time. Outside information includes weather forecasts, grid frequency deviations, local voltage sags, or other information provided by the utility.
- **Unplanned Transition:** In an unplanned transition, an unanticipated outage takes place such as the loss of a transformer, or a car hitting a distribution power pole. Depending on the microgrid resources operating at the time, an outage may take place which requires the microgrid to establish itself through a black start sequence of operation.

The resources included in the Warwick microgrid will be sized and operated to support island operation for a minimum period of seven days, with multi-week operation likely. During island mode operation, the microgrid control system will maintain system stability and ensure a balance of generation and load. The controller will forecast critical load and PV generation, and then dispatch resources to match the load. We anticipate that the resources available to be controlled during island operations will include CHP, fossil fuel generators, PV systems, energy storage, and building load. The team also expects that the utility will be able to provide an estimated time to restoration. This estimate will be used to help determine the remaining duration of island operation required, and will influence the dispatch of microgrid resources.

The design strategy for the Warwick microgrid is to supply the critical load at a level that enables the critical services that keep the community functioning at an “80% level” throughout the entire event duration. In other words, the microgrid is not intended to address 100% of resilience needs for all critical community assets – but to cover about 80% of those needs. Specifically, the proposed microgrid would provide full functionality for police, fire, and emergency services, while also providing resilient power and heat for some additional facilities. The system will substantially reduce the stress on emergency services and on residents generally during a long-duration outage.

## 2.2 Load Characterization

### Modeling Methodology

The microgrid was modeled using HOMER Pro (Hybrid Optimization Model for Multiple Energy Resources). HOMER Pro is a microgrid software tool originally developed at the National Renewable Energy Laboratory (NREL), and enhanced and distributed by HOMER Energy. HOMER nests three integrated tools in one software product, allowing microgrid design and economics to be evaluated concurrently. The key features of HOMER Pro are:

- **Simulation:**  
HOMER simulates the operation of a hybrid microgrid for an entire year, in time steps from one minute to one hour.
- **Optimization:**

HOMER examines all possible combinations of system types in a single run, and then sorts the systems according to the optimization variable of choice.

- **Sensitivity Analysis:**

HOMER allows the user to run models using hypothetical scenarios. The user cannot control all aspects of a system, and cannot know the importance of a particular variable or option without running hundreds or thousands of simulations and comparing the results. HOMER makes it easy to compare thousands of possibilities in a single run.

### Load Description

The microgrid design team modeled and optimized each of the ten nodes separately. Table II-B presents an overview of the energy operations of the microgrid for annual and monthly average values. The microgrid will have a maximum demand of 6,498 kW and an average demand of 996 kW. The microgrid will deliver approximately 8,700,000 kWh per year. The thermal loads in the microgrid will be approximately 38,300,000 kBTU per year, of which approximately 22,700,000 kBTU will be recovered from the CHP systems and reused to support on-site thermal loads.

**Table II-B –Microgrid Energy Overview: Grid Connected Operation**

Node	Electric Demand		Electric Consumption		Thermal Load		Thermal Recovery	
	Max (kW)	Avg (kW)	kWh/year	kWh/month	kBTU/year	kBTU/month	kBTU/year	kBTU/month
1	2,180	805	7,047,657	587,305	31,912,123	2,659,344	20,593,823	1,716,152
2	36	7	59,184	4,932	785,835	65,486	149,140	12,428
3	116	26	226,586	18,882	1,066,387	88,866	257,437	21,453
4	94	40	350,580	29,215	381,107	31,759	345,156	28,763
5*	18	3	23,623	1,969	0	0	0	0
6	65	15	129,487	10,791	924,267	77,022	189,485	15,790
7	62	15	129,754	10,813	500,046	41,670	198,245	16,520
8*	18	9	80,174	6,681	0	0	0	0
9	131	58	509,294	42,441	655,923	54,660	568,189	47,349
10	67	19	165,971	13,831	2,210,898	184,241	222,442	18,537
<b>Total</b>	<b>2,787</b>	<b>996</b>	<b>8,722,310</b>	<b>726,859</b>	<b>38,436,586</b>	<b>3,203,049</b>	<b>22,523,916</b>	<b>1,876,993</b>

\* Node does not include CHP

The monthly energy delivery by microgrid node are presented in Table 3 and presented graphically in Figure II-B.



**Table II-C –Monthly Grid Connected Operation by Node**

Month	Node 1	Node 2	Node 3	Node 4	Node 5	Node 6	Node 7	Node 8	Node 9	Node 10	Total
	(kWh)										
Jan	572,373	4,291	19,496	35,028	1,522	12,171	9,740	9,575	48,237	18,921	731,354
Feb	466,031	4,130	17,293	25,781	4,614	10,772	9,279	8,288	43,787	17,118	607,093
Mar	542,109	4,746	18,121	30,277	4,412	12,878	9,953	9,239	49,420	14,145	695,301
Apr	526,115	4,099	17,137	29,343	3,682	12,510	8,097	7,647	48,418	13,984	671,032
May	588,538	3,684	16,823	29,781	1,691	7,323	9,923	5,650	40,240	14,638	718,292
Jun	666,895	5,629	20,930	28,382	1,020	10,827	13,897	5,123	37,953	8,942	799,600
Jul	675,618	5,813	23,286	24,235	1,018	13,651	14,851	4,526	36,987	8,649	808,633
Aug	753,814	7,935	22,202	26,952	1,136	12,952	15,291	4,739	38,868	9,479	893,369
Sep	649,987	5,340	21,117	27,748	1,163	10,413	12,846	3,949	37,715	13,809	784,088
Oct	581,766	4,821	16,028	29,829	1,147	9,330	9,437	4,397	38,865	14,450	710,071
Nov	523,264	4,033	17,321	32,556	1,102	7,719	7,098	7,803	43,006	13,344	657,247
Dec	501,146	4,662	16,831	30,667	1,114	8,941	9,342	9,237	45,797	18,492	646,230
<b>Total</b>	<b>7,047,657</b>	<b>59,184</b>	<b>226,586</b>	<b>350,580</b>	<b>23,623</b>	<b>129,487</b>	<b>129,754</b>	<b>80,174</b>	<b>509,294</b>	<b>165,971</b>	<b>8,722,310</b>

**Fig. II-B - Monthly Grid Connected Operation by Node**

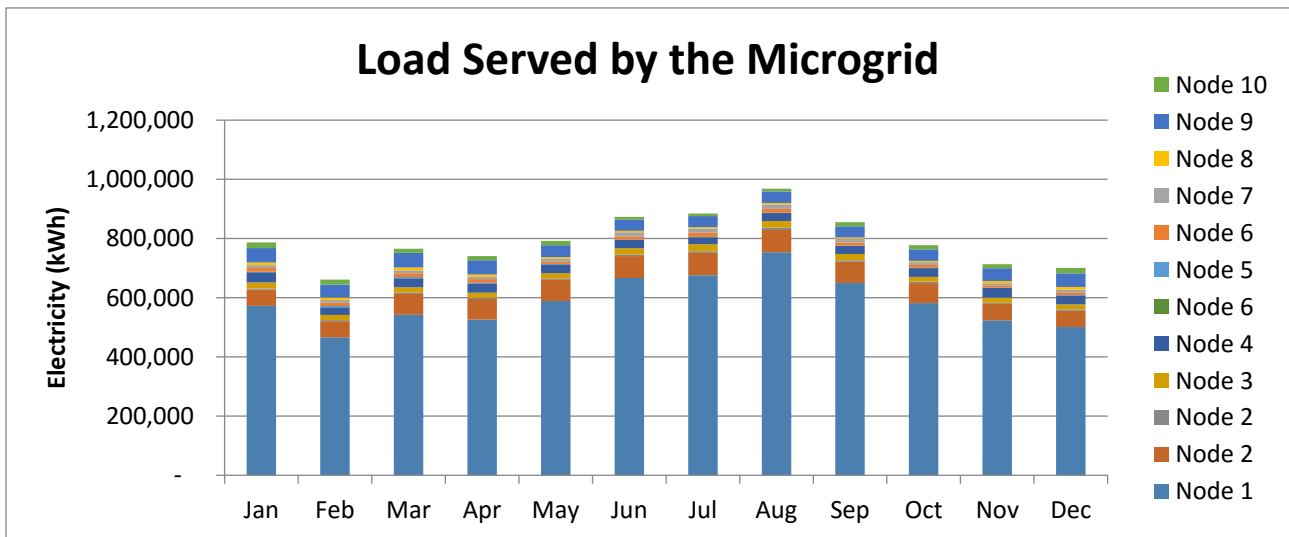

Note: Table II-C and Fig. II-B show a decrease in energy use across almost all nodes in the month of February. More than half of the decrease is attributable to the fact that February has fewer days than other months do (8 percent fewer on average). The table also shows a significant increase in energy usage from February to April in Node 5. This is based on the actual billing data for the Memorial Park Drive Pumping Station. Similar increases over this period were observed during both of the past two years for this facility, and may be attributed to annual O&M activities.

Each node was modeled for operation during an extended outage (one week) to evaluate and optimize microgrid resources operating in island mode. Two outage events were modeled which represent an outage during the winter and an outage during the summer. Energy flows during the outages are presented as weekly averages in Table II-D.

**Table II-D –Microgrid Energy Overview: Island Mode Operation**

Node	Season	Electric Demand		Electric Consumption	Thermal Load	Thermal Recovery
		Max (kW)	Avg (kW)	kWh/week	kBTU/week	kBTU/week
1	Winter	1,566	893	150,036	1,079,958	249,531
	Summer	1,455	855	143,609	338,221	248,064
2	Winter	21	6	1,086	35,829	3,862
	Summer	26	7	1,234	2,559	2,539
3	Winter	72	25	4,174	55,112	9,145
	Summer	78	28	4,669	5,276	4,965
4	Winter	100	55	9,232	19,277	9,564
	Summer	73	36	6,126	0	0
5*	Winter	18	2	398	0	0
	Summer	2	2	258	0	0
6	Winter	59	19	3,194	54,604	7,131
	Summer	41	16	2,646	0	0
7	Winter	34	14	2,277	26,532	7,077
	Summer	42	17	2,914	1,283	1,282
8*	Winter	31	15	2,527	0	0
	Summer	17	7	1,128	0	0
9	Winter	124	75	12,681	32,568	16,062
	Summer	103	55	9,275	641	641
10	Winter	65	24	4,058	105,700	9,494
	Summer	38	13	2,197	583	549
Total	Winter	2,090	1,129	189,662	1,409,579	311,866
	Summer	1,876	1,036	174,056	348,563	258,041

\* Node does not have CHP

## Development of Hourly Load Profiles

The team developed hourly load profiles for the microgrid using the approach and assumptions described below.

### Electric Load Profile

The design team used licensed HOMER Pro microgrid modeling software (as described above) to generate electrical load profiles for the proposed Warwick microgrid design. The design team employed a data retrieval and pre-modeling process in order to generate inputs for the software. First, the design team requested the most recent twelve-month period of electric usage (kWh), peak demand (kW), and costs for each facility under consideration for inclusion in the design. Using a proprietary Hitachi pre-modeling tool, this data was used to estimate hourly load by facility over a 12-month period.

The Hitachi pre-modeling tool was designed to take the set of available monthly usage and peak demand data, and, based on preset hourly loads for a variety of building types (commercial, industrial, residential, etc.) defined by the HOMER Pro microgrid modeling software, generate a typical hourly load profile per month for each building. Then, the set of available peak demand data was used to manually adjust the pre-populated hourly load profile until the total usage for each month was within +/- 10 percent of the actual given usage. The design team determined that +/- 10 percent was an acceptable confidence interval to satisfy the overall +/- 30 percent confidence interval required for this NY Prize Stage 1 analysis. This manual manipulation was employed only in instances where the pre-populated hourly load profile yielded total monthly usage values outside of the +/- 10 percent confidence interval, generating a more accurate depiction of peak and hourly load profiles that are characteristic across the portfolio of unique buildings within Warwick.

The output values from this pre-modeling step were then inserted into the HOMER Pro microgrid modeling software for simulation, optimization, and analysis. The HOMER Pro tool allows for the input of daily load profiles and then adds in some randomness. This process produces one year of hourly load data. To address the potential randomness, HOMER Pro applies a 10 percent day-to-day variability and a 20 percent time-step variability. This level of variability provides for appropriate diversity from estimated loads and potential changes in operation for the clients, due to business needs.

Complete sets of electric data were collected for many of the facilities included in the microgrid as indicated in II-E. However, for some buildings stakeholders provided either a subset or none of the requested 12-month set of data. In these cases, the data from similar-type buildings within the region were used to estimate monthly usage and peak demand based on the relative building area. The design team then applied the same pre-modeling process described above to these sets of data to estimate hourly load. This approach was applied to three buildings in Warwick: CVS, Sunoco, and Warwick Rescue Squad.

In other cases when limited data was available, and the design team did not have access to any similar (in terms of operating characteristics) buildings' data within the region from which the design team could estimate usage. The design team used data from the Energy Index for Commercial Buildings, which is based on the Energy Information Administration's (EIA) 2003 Commercial Buildings Energy Consumption Survey (CBECS), to generate an annual per-square-foot energy consumption amount for each building, scaling it to each building's total square footage. The design team then applied the same pre-modeling process described above to these sets of data to estimate hourly load. This approach applied to nine buildings in Warwick: Alteva - Warwick Valley Long Distance, Craft Beer Cellar/Taco Hombre/Warwick Thai, Dunkin' Donuts, Key Bank, Mr. Bill's Auto Repair, NAPA Auto Parts, TD Bank, Tokyo Plum House/Miller Ski & Sport/Chosun Taekwondo Academy, and Warwick Auto Body/Sensible Car Rental.

Table II-E summarizes the electric data collection and load estimate approach for each facility:

**Table II-E – Monthly Electric Data Provided to Project Team for Analysis**

Facility		Jan	Feb	Mar	Apr	May	Jun	Jul	Aug	Sep	Oct	Nov	Dec
Alteva - Warwick Valley Long Distance	Usage	<i>Estimated using CBECS 2003 data</i>											
	Demand	<i>Estimated using CBECS 2003 data</i>											
Craft Beer Cellar/Taco Hombro/Warwick Thai	Usage	<i>Estimated using CBECS 2003 data</i>											
	Demand	<i>Estimated using CBECS 2003 data</i>											
CVS	Usage	<i>Estimated using similar-type building data</i>											
	Demand	<i>Estimated using similar-type building data</i>											
DPW Garage/Fuel Depot	Usage		X					X					
	Demand		X					X					
Dunkin' Donuts	Usage	<i>Estimated using CBECS 2003 data</i>											
	Demand	<i>Estimated using CBECS 2003 data</i>											
Fire Station - 132 South Street Ext	Usage	X	X	X	X	X	X	X	X	X	X	X	X
	Demand	X	X	X	X	X	X	X	X	X	X	X	X
Freshwater Pumping Station	Usage	X	X	X	X	X	X	X	X	X	X	X	X
	Demand	X	X	X	X	X	X	X	X	X	X	X	X
Key Bank	Usage	<i>Estimated using CBECS 2003 data</i>											
	Demand	<i>Estimated using CBECS 2003 data</i>											
Memorial Park Water Pump	Usage	X	X	X	X	X	X	X	X	X	X	X	X
	Demand	X	X	X	X	X	X	X	X	X	X	X	X
Micro Filtration Station - Memorial Dr.	Usage	X	X	X	X	X	X	X	X	X	X	X	X
	Demand	X	X	X	X	X	X	X	X	X	X	X	X
Mr. Bill's Auto Repair	Usage	<i>Estimated using CBECS 2003 data</i>											
	Demand	<i>Estimated using CBECS 2003 data</i>											
Mt. Alverno Center & Schervier Pavilion	Usage	X	X	X	X	X	X	X	X	X	X	X	X
	Demand		X					X					
NAPA Auto Parts	Usage	<i>Estimated using CBECS 2003 data</i>											
	Demand	<i>Estimated using CBECS 2003 data</i>											
Orchard St. Pumping Station	Usage	X	X	X	X	X	X	X	X	X	X	X	X
	Demand	X	X	X	X	X	X	X	X	X	X	X	X
St. Anthony's Community Hospital	Usage	X	X	X	X	X	X	X	X	X	X	X	X
	Demand	X	X	X	X	X	X	X	X	X	X	X	X

<b>Sunoco</b>	Usage	<i>Estimated using similar-type building data</i>											
	Demand												
<b>TD Bank</b>	Usage	<i>Estimated using CBECS 2003 data</i>											
	Demand												
<b>Tokyo Plum House/Miller Ski &amp; Sport/Chosun Taekwondo Academy</b>	Usage	<i>Estimated using CBECS 2003 data</i>											
	Demand												
<b>Warwick Auto Body/Sensible Car Rental</b>	Usage	<i>Estimated using CBECS 2003 data</i>											
	Demand												
<b>Warwick Fire Dept - 25 Church St.</b>	Usage	X	X	X	X	X	X	X	X	X	X	X	X
	Demand	X	X	X	X	X	X	X	X	X	X	X	X
<b>Warwick Rescue Squad</b>	Usage	<i>Estimated using similar-type building data</i>											
	Demand												
<b>Warwick Town Hall &amp; Police</b>	Usage	X	X	X	X	X	X	X	X	X	X	X	X
	Demand	X	X	X	X	X	X	X	X	X	X	X	X
<b>Warwick Village Hall</b>	Usage			X				X					
	Demand			X				X					
<b>Wastewater Treatment Plant - River Street Pump</b>	Usage	X	X	X	X	X	X	X	X	X	X	X	X
	Demand	X	X	X	X	X	X	X	X	X	X	X	X
<b>Wastewater Treatment Plant - State School Road</b>	Usage	X	X	X	X	X	X	X	X	X	X	X	X
	Demand		X					X					
<b>Water Filtration Plant - Off Southern Lane</b>	Usage	X	X	X	X	X	X	X	X	X	X	X	X
	Demand	X	X	X	X	X	X	X	X	X	X	X	X

### Natural Gas Load Profile

Similar to the process for modeling hourly electric load profiles, the design team used licensed HOMER Pro microgrid modeling software to generate natural gas load profiles for the proposed Warwick microgrid design. The team requested the most recent twelve-month period of available natural gas bills (or fuel oil bills if applicable) from community stakeholders for each facility under consideration for inclusion in the design. Using a proprietary Hitachi pre-modeling tool, this data was used to estimate hourly natural gas load by facility over a 12-month period. The output values from this pre-modeling step were then input into HOMER Pro in the same manner as the electric load data discussed above.

Complete sets of natural gas data were collected for many of the facilities included in the microgrid as indicated in Table II-F. However, for some buildings stakeholders provided either a subset or none of the requested twelve-month set of data. In these cases, the data from similar-type buildings within the region were used to estimate monthly usage and peak demand based on the relative building area. The project team then applied the same pre-modeling process described above to these sets of data to estimate hourly load. This approach applied to four buildings in Warwick: Key Bank, Micro Filtration Station - Memorial Dr., TD Bank, and Wastewater Treatment Plant - State School Road.

In other cases when limited data was available, and the design team did not have access to any similar (in terms of operating characteristics) buildings' data within the region from which the design team could estimate usage. The design team used data from The Energy Index for Commercial Buildings, which is based on the Energy Information Administration's (EIA) 2003 Commercial Buildings Energy Consumption Survey (CBECS), to generate an annual per-square-foot energy consumption amount for each building, scaling it to each building's total square footage. The design team then applied the same pre-modeling process described above to these sets of data to estimate hourly load. This approach applied to 10 buildings in Warwick: Alteva – Warwick Valley Long Distance, Craft Beer Cellar/Taco Hombre/Warwick Thai, CVS, Dunkin' Donuts, Mr. Bill's Auto Repair, NAPA Auto Parts, Sunoco, Tokyo Plum House/Miller Ski & Sport/Chosun Taekwondo Academy, Warwick Auto Body/Sensible Car Rental, and Warwick Rescue Squad.

Table II-F summarizes the natural gas data collection and load estimate approach for each facility:

**Table II-F –Monthly Thermal Data Provided to Project Team for Analysis**

Facility	Jan	Feb	Mar	Apr	May	Jun	Jul	Aug	Sep	Oct	Nov	Dec
Alteva – Warwick Valley Long Distance	<i>Estimated using CBECS 2003 data</i>											
Craft Beer Cellar/Taco Hombre/Warwick Thai	<i>Estimated using CBECS 2003 data</i>											
CVS	<i>Estimated using CBECS 2003 data</i>											
DPW Garage/Fuel Depot	X	X	X	X	X	X	X	X	X	X	X	X
Dunkin' Donuts	<i>Estimated using CBECS 2003 data</i>											
Fire Station - 132 South Street Ext	X	X	X	X	X	X	X	X	X	X	X	X
Key Bank	<i>Estimated using similar-type building data</i>											
Micro Filtration Station - Memorial Dr.	<i>Estimated using similar-type building data</i>											
Mr. Bill's Auto Repair	<i>Estimated using CBECS 2003 data</i>											
Mt. Alverno Center & Schervier Pavilion	X	X	X	X	X	X	X	X	X	X	X	X
NAPA Auto Parts	<i>Estimated using CBECS 2003 data</i>											
St. Anthony's Community Hospital	X	X	X	X	X	X	X	X	X	X	X	X
Sunoco	<i>Estimated using CBECS 2003 data</i>											
TD Bank	<i>Estimated using similar-type building data</i>											
Tokyo Plum House/Miller Ski & Sport/Chosun Taekwondo Academy	<i>Estimated using CBECS 2003 data</i>											
Warwick Auto Body/Sensible Car Rental	<i>Estimated using CBECS 2003 data</i>											
Warwick Fire Dept - 25 Church St.	X	X	X	X	X	X	X	X	X	X	X	X
Warwick Rescue Squad	<i>Estimated using CBECS 2003 data</i>											
Warwick Town Hall & Police	X	X	X	X	X	X	X	X	X	X	X	X
Warwick Village Hall		X					X					
Wastewater Treatment Plant - River Street Pump	X	X	X	X	X	X	X	X	X	X	X	X
Wastewater Treatment Plant - State School Road	<i>Estimated using similar-type building data</i>											
Water Filtration Plant - Off Southern Lane	X	X	X	X	X	X	X	X	X	X	X	X

## Sizing Loads and System Redundancy

The traditional reserve margins and redundancy that the utility industry uses to describe elements of reliability do not necessarily apply to microgrids. For example, the utility grid employs reserve margins at 15% to 23% and N-1 contingency criteria where the grid can accommodate the loss of the largest single unit in a utility control area. However, this approach assumes the transmission and distribution line infrastructure is intact, yet experience shows that the major contributors to loss of grid supply to customers are related to line infrastructure. A long history of grid performance data demonstrates that “redundancy” (reserve margin and N-1 contingency criteria) has little to do with reliability at the customer site.

In contrast to this, experience with operating microgrids within the US and overseas that this microgrid approach yields a great deal more uptime for the customer than the utility system, which employs reserve margins and redundancy measures for the grid.

The Warwick microgrid is designed for 80% to 86% energy supply from on-site resources, with the remainder of the energy coming from the grid when the grid is operating. The microgrid treats the utility grid as an additional resource and includes reliability history of the grid into reliability optimization.

The reliability of the Warwick microgrid will be ensured with the following measures:

- The use of multiple, distributed, smaller unit sizes to help minimize generation loss and ensure that the microgrid can gracefully accommodate a failure.
- The use of distributed energy storage systems that can accommodate short periods of high loading if the resource loss reason is known and quickly recoverable (15 minutes).
- Increasing the energy dispatch from the grid (in grid-connected mode - 99% of the time), to accommodate the loss of a resource until recovered.
- The use of a combination of ESS and load modulation (up to 20% without curtailment) in island mode to accommodate the loss of a resource for a few hours. Beyond a few hours, non-critical loads will be shut down until the resource is recovered.
- Greater use of underground cabling and indoor infrastructure than is typical in the existing utility grid.

These techniques are employed in the Warwick Microgrid design so that equipment loss is mitigated or accommodated in the specific microgrid nodes for this community, under grid-connected and islanded modes of operation. Table II-G summarizes the microgrid resources in each node in terms of number of devices and the total installed capacity by technology.



**Table II-G - Microgrid Node Resources Comparison**

Node	Operation Scenario	Grid	PV		Battery Energy Storage		Natural Gas Engine or CHP		Backup Generators	
		Peak kW	# of Inverters	kW	Quantity	kW / kWh	Quantity	kW	Quantity	kW
1	Business as Usual	2,180	1	60	-	-	-	0	2	790
	Microgrid	700	5	900	4	35 / 70	4	623	2	790
2	Business as Usual	36	-	0	-	-	-	-	-	-
	Microgrid	15	1	9	1	5 / 10	1	5	-	-
3	Business as Usual	116	1	24	-	-	-	0	-	-
	Microgrid	40	2	70	1	10 / 20	1	15	-	-
4	Business as Usual	94	-	0	-	-	-	-	1	447
	Microgrid	45	1	60	1	5 / 10	1	30	1	447
5	Business as Usual	18	-	0	-	-	-	0	1	150
	Microgrid	14	1	20	1	5 / 10	0	0	1	150
6	Business as Usual	65	-	0	-	-	-	-	1	45
	Microgrid	20	1	32	1	5 / 10	1	10	1	45
7	Business as Usual	62	-	0	-	-	-	0	-	-
	Microgrid	15	1	30	1	5 / 10	2	10	-	-
8	Business as Usual	18	-	0	-	-	-	-	1	90
	Microgrid	18	1	24	1	5 / 10	0	0	1	90
9	Business as Usual	131	-	0	-	-	-	0	-	-
	Microgrid	74	1	80	1	5 / 10	1	40	-	-
10	Business as Usual	67	-	0	-	-	-	-	1	6
	Microgrid	30	1	40	1	5 / 10	2	15	1	6

**2.3 Distributed Energy Resources Characterization**

A variety of generation sources are planned for the community microgrid. They include the following:

- Combined Heat and Power (CHP)
- Solar Photovoltaics (PV)
- Energy Storage System (ESS)
- Building Load Control
- Energy Efficiency Measures (EEMs)
- Utility Grid
- Backup Generators

The energy efficiency measures (EEM) that are planned for the Warwick microgrid have been taken into account for the final sizing of the microgrid portfolio of resources. This ensures that the microgrid resources are not oversized. Some of the EEM measures selected for this project include the installation of LED lighting, premium efficiency motors, variable speed drives, and advanced building controls.

CHP units will be co-located with the thermal loads of targeted buildings. Solar PV arrays will be located opportunistically on suitable rooftops, in parking areas, and in locations where opportunities for ground mount arrays exist. Energy storage units will be sited near the solar PV arrays, with preference for indoor locations. Existing backup generators will be leveraged to support island operations in conjunction with the new DER. New DER will minimize the need for the backup generator operation to minimize usage of diesel fuel, propane, and natural gas.

An overview of each technology, installation, operating strategy, and modeled operation are presented in this section.

### Combined Heat and Power (CHP)

CHP generators provide electrical and thermal energy from a single source. The use of fuel to generate both heat and power makes CHP systems more efficient and cost effective separate power and thermal generation systems. Most power generation produces heat as a byproduct, but because power is generated far from the end user, the heat is lost. CHP units take advantage of the fact that they are collated with the end user, and make use of thermal energy for heating and sometimes even cooling nearby buildings. For this microgrid application, internal combustion engine based CHP systems have been modeled. Internal combustion engines, also called reciprocating engines, use a reciprocating motion to move pistons inside cylinders that turn a shaft and produce power. Internal combustion engines typically range between 5 kW and 7 MW in capacity and are best suited for load-following applications. Fig. II-C illustrates an internal combustion engine generator.

**Figure II-C – CHP System Overview**

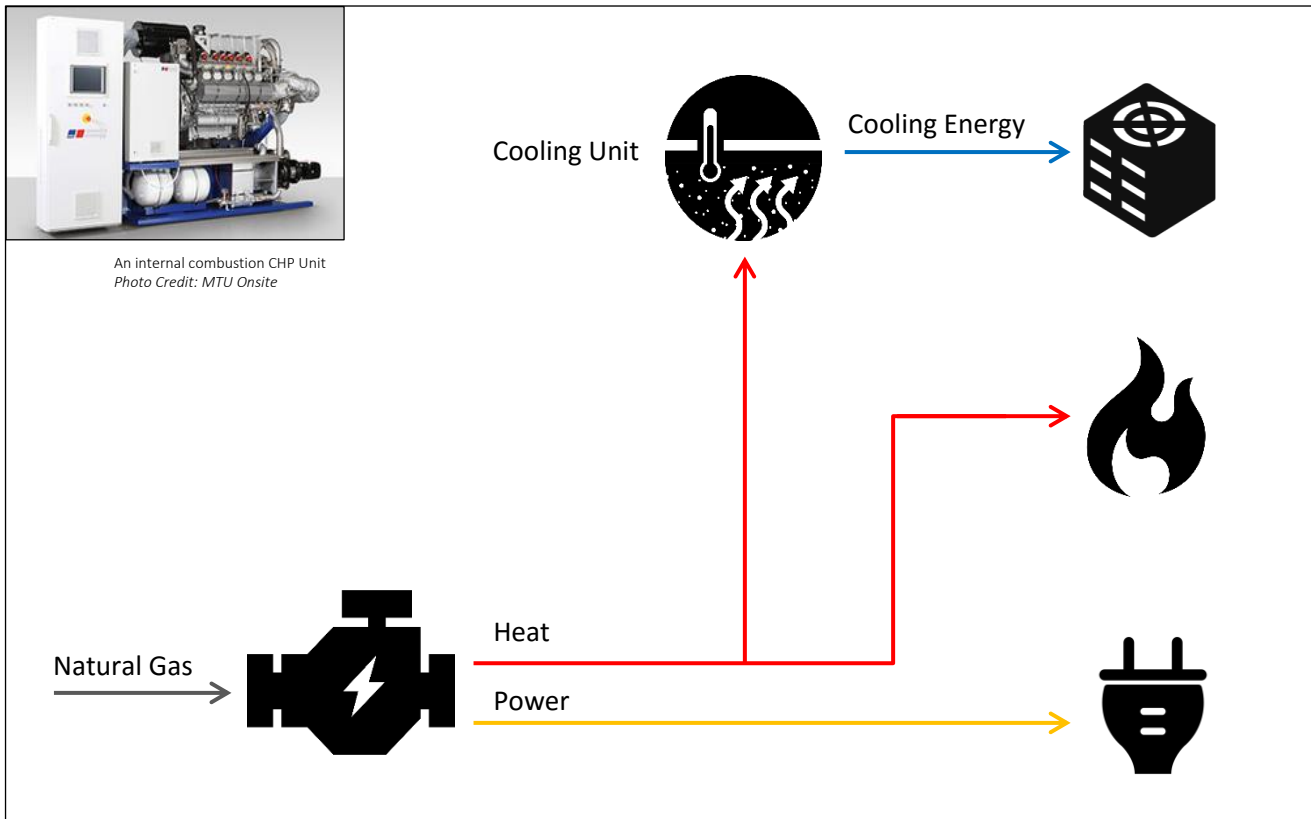

**Benefits of CHP**

- Reduces utility costs and improves economic competitiveness
- Increases power reliability and self-sufficiency
- Reduces GHG emissions and other pollutants
- Reduces demand for imported energy supplies
- Capable of operating on renewable or nonrenewable resources
- Suite of proven, commercially available technologies for various applications
- Additional financial incentives through the NYSERDA and investment tax credits available for eligible customers

**CHP Approach**

- Co-Locate generators near thermal loads on the customer-side of the meter
- Design for base load operation of ~8,500 hrs/yr, and to maximize heat recovery when grid connected
- Support microgrid operations when the electric grid is not available along with PV, energy storage, and building load control
- Design to serve specific winter Heat Recovery Loads, such as a boiler plant, space heating, DHW and pool heating
- Design to serve specific summer Heat Recovery Loads, including space cooling, DHW and pool heating

**CHP in the Microgrid**

Table II-H summarizes the CHP components by node of the microgrid. *Note:* See the layout diagram in Appendix A and single-line diagram in Appendix B for details regarding size and location of the planned CHP units.

**Table II-H - Microgrid CHP Resources by Node**

Node	Natural Gas Engine or CHP	
	Quantity	Total kW
1	4	623
2	1	5
3	1	15
4	1	30
5	0	0
6	1	10
7	2	10
8	0	0
9	1	40
10	2	15
<b>Total</b>	<b>13</b>	<b>748</b>

The below tables and figures describe the annual operation of the CHP fleet in the Warwick microgrid.

**Table II-I - Microgrid CHP Electric Production by Node**

Month	Node 1	Node 2	Node 3	Node 4	Node 5	Node 6	Node 7	Node 8	Node 9	Node 10	Total
<b>Electric Production (kWh)</b>											
Jan	426,015	3,252	9,311	19,796	0	6,469	6,368	0	27,706	9,667	<b>508,584</b>
Feb	372,819	2,949	8,158	17,572	0	5,687	5,696	0	24,875	8,939	<b>446,695</b>
Mar	394,696	3,182	7,073	18,944	0	6,503	5,799	0	27,365	6,913	<b>470,476</b>
Apr	392,706	2,754	7,153	17,916	0	6,282	4,354	0	26,817	7,134	<b>465,116</b>
May	413,591	2,422	7,127	18,886	0	3,524	5,740	0	24,656	7,128	<b>483,074</b>
Jun	411,536	3,439	8,064	17,815	0	6,040	6,738	0	23,310	4,873	<b>481,816</b>
Jul	439,772	3,566	8,469	15,089	0	6,498	7,098	0	22,654	4,732	<b>507,878</b>
Aug	452,832	3,703	8,222	17,360	0	6,323	7,071	0	23,422	5,431	<b>524,365</b>
Sep	415,992	3,128	7,828	17,598	0	5,604	6,412	0	22,845	6,710	<b>486,116</b>
Oct	423,873	3,406	7,349	19,026	0	5,457	5,829	0	24,189	7,573	<b>496,701</b>
Nov	396,262	3,024	7,564	19,713	0	4,897	4,630	0	26,041	6,933	<b>469,064</b>
Dec	350,918	3,396	7,656	20,489	0	6,239	6,368	0	27,580	9,442	<b>432,088</b>
<b>Total</b>	<b>4,891,011</b>	<b>38,219</b>	<b>93,973</b>	<b>220,205</b>	<b>0</b>	<b>69,525</b>	<b>72,103</b>	<b>0</b>	<b>301,460</b>	<b>85,476</b>	<b>5,771,972</b>

**Fig. II-D – Microgrid CHP Electric Production**

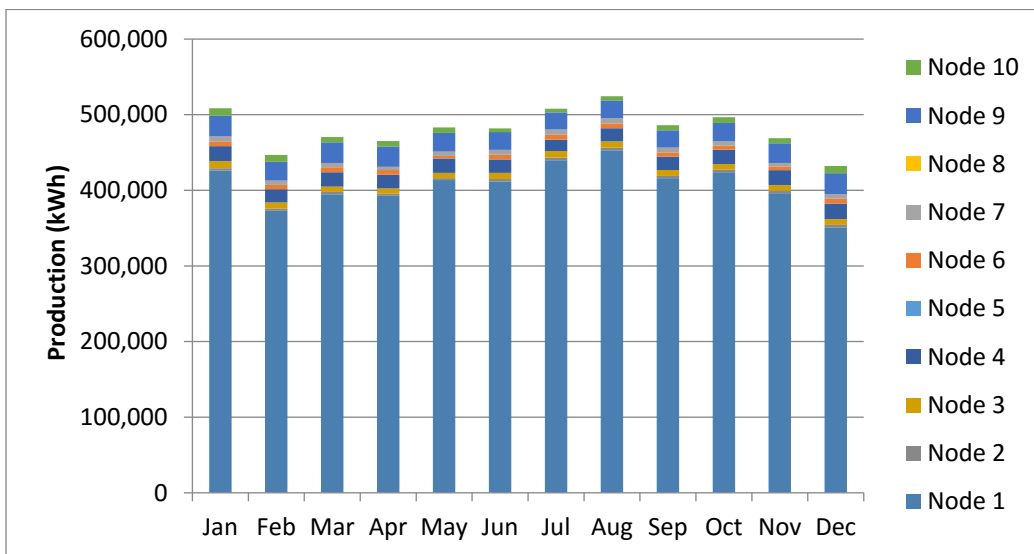

**Table II-J - Microgrid CHP Heat Recovery by Node**

Month	Node 1	Node 2	Node 3	Node 4	Node 5	Node 6	Node 7	Node 8	Node 9	Node 10	Total
	<b>Heat Recovery (kBTU)</b>										
<b>Jan</b>	2,141,783	14,402	35,355	62,492	0	28,654	28,197	0	95,940	36,726	2,443,549
<b>Feb</b>	1,797,751	13,060	31,087	55,330	0	25,188	25,225	0	85,076	34,070	2,066,787
<b>Mar</b>	2,033,348	14,092	26,648	57,112	0	28,804	25,681	0	92,581	26,105	2,304,370
<b>Apr</b>	1,886,381	12,196	25,730	30,085	0	27,822	19,069	0	56,265	26,853	2,084,401
<b>May</b>	1,503,552	10,715	19,747	12,371	0	15,604	12,048	0	22,308	25,772	1,622,117
<b>Jun</b>	1,302,876	12,076	16,172	5,015	0	11,576	7,435	0	10,024	3,489	1,368,662
<b>Jul</b>	1,327,174	9,911	19,085	5	0	11	5,043	0	2,527	2,193	1,365,948
<b>Aug</b>	1,367,034	10,519	12,472	2,633	0	0	7,864	0	5,270	1,442	1,407,234
<b>Sep</b>	1,488,586	9,293	11,816	2,495	0	0	6,184	0	7,479	1,356	1,527,210
<b>Oct</b>	1,965,062	14,447	3,311	12,459	0	2,529	13,565	0	22,480	2,490	2,036,342
<b>Nov</b>	1,982,922	13,391	27,149	45,472	0	21,665	19,771	0	76,372	26,071	2,212,812
<b>Dec</b>	1,797,355	15,039	28,866	59,688	0	27,632	28,163	0	91,868	35,874	2,084,483
<b>Total</b>	<b>20,593,823</b>	<b>149,140</b>	<b>257,437</b>	<b>345,156</b>	<b>0</b>	<b>189,485</b>	<b>198,245</b>	<b>0</b>	<b>568,189</b>	<b>222,442</b>	<b>22,523,916</b>

**Figure II-E – Microgrid CHP Heat Recovery**

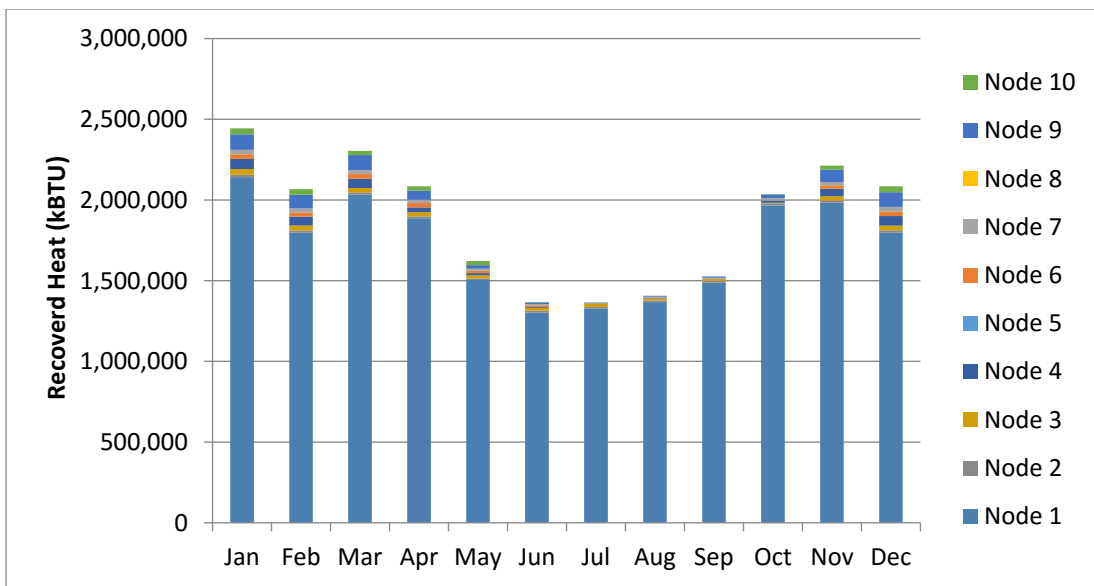
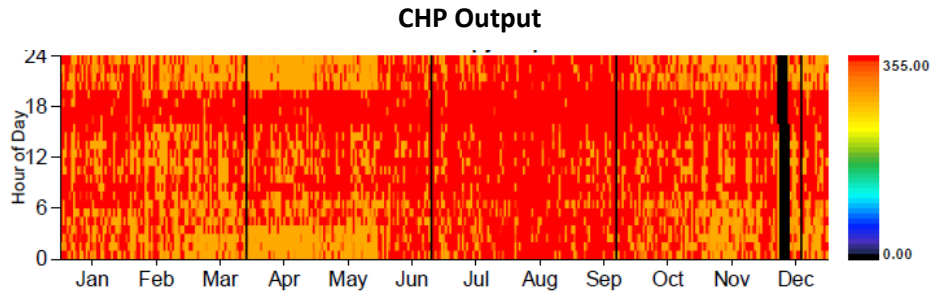

Figure 8 presents the hourly operation of the CHP in Node 1 in the form of a heat map. This representation demonstrates how the CHP unit is operating a near full capacity during normal business hours (red) and then does some electric load following during the non-business hours (orange) but is loaded at an overall high level of output during the course of the year.

**Figure II-F – Node #1 CHP Operational Summary**



**Solar Photovoltaics**

The solar photovoltaic systems (PV) will be rooftop, parking lot or ground mounted using hail-rated solar panels. PV devices generate electricity directly from sunlight via an electronic process that occurs naturally in certain types of material, called semiconductors. Electrons in these materials are freed by photons and can be induced to travel through an electrical circuit resulting in the flow of electrons to create energy in the form of direct current. An inverter transforms the direct current into usable alternating current. Figure II-G illustrates a typical customer-sited PV installation.

**Figure II-G – PV Installation Diagram (Customer Side of Meter)**

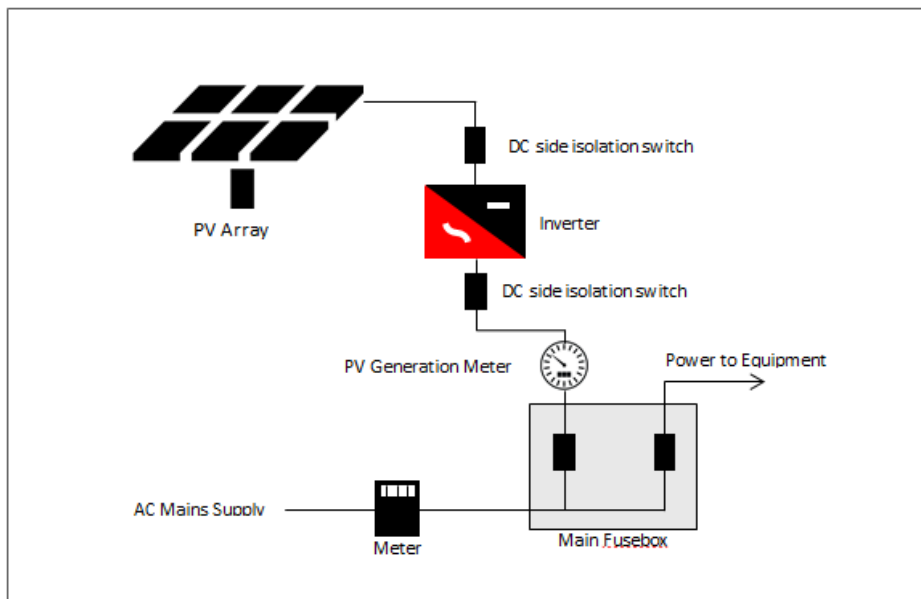

Since the PV systems are driven by sunlight, the electric production profile varies with the position of the sun and is impacted by the level of cloud cover. Figure II-H presents the typical average daily PV

generation profiles by month and demonstrates the seasonal variation of PV as a generation resource. The HOMER model takes this variability into account when simulating and optimizing the sizing of PV as a microgrid resource.

**Figure II-H – Typical PV Daily Generation Profiles**

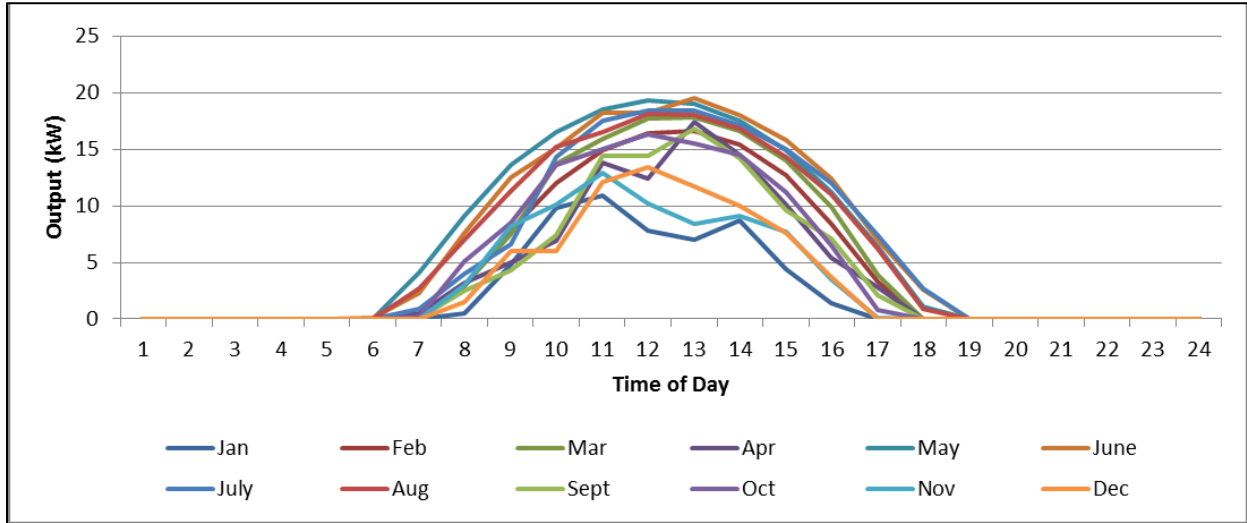

PV systems are planned for rooftops, parking spaces, and ground-mount configurations. Figure 11 presents examples of each these types of installations.

**Figure II-I – PV Installation Options.**



### Benefits of PV

- Reduces utility costs and improves economic competitiveness
- Increases power reliability and self-sufficiency
- Reduces GHG emissions and other pollutants
- Reduces demand for imported energy supplies
- Fueled by a renewable resource
- Based on a suite of proven, commercially available technologies for a variety of applications
- Competitive market for hardware and installation services

### PV Approach

- Co-locate PV systems on the customer-side of the meter to support resiliency
- Install on roofs, ground mount and covered parking
- Provide renewable energy resource (reduce site emissions and no fuel cost)
- Support day-time load requirements and annual energy loads (grid connected operation)
- Support microgrid operations when the electric grid is not available along with CHP, energy storage, and building load control

### PV in the Microgrid

Table II-J summarizes the PV components by node of the microgrid. See also the layout diagram and single-line diagram in the appendix for details regarding size and locations of the planned PV systems.

**Table II-K - Microgrid PV Resources by Node**

Node	PV	
	# of Inverters	Total kW
1	4	900
2	1	9
3	1	70
4	1	60
5	1	20
6	1	32
7	2	30
8	1	24
9	1	80
10	1	40
<b>Total</b>	<b>14</b>	<b>1,265</b>

Table II-L and figures II-J and II-K describe the PV fleet.



**Table II-L – Microgrid PV Fleet Electric Production**

Month	Node1	Node 2	Node 3	Node 4	Node 5	Node 6	Node 7	Node 8	Node 9	Node 10	Total
<b>Electric Production (kWh)</b>											
Jan	79,370	794	6,173	5,291	1,764	2,822	2,646	2,117	7,055	3,528	111,558
Feb	88,279	883	6,866	5,885	1,962	3,139	2,943	2,354	7,847	3,924	124,081
Mar	122,651	1,227	9,540	8,177	2,726	4,361	4,088	3,271	10,902	5,451	172,393
Apr	110,603	1,106	8,602	7,374	2,458	3,933	3,687	2,949	9,831	4,916	155,458
May	117,404	1,174	9,131	7,827	2,609	4,174	3,913	3,131	10,436	5,218	165,018
Jun	111,799	1,118	8,696	7,453	2,484	3,975	3,727	2,981	9,938	4,969	157,140
Jul	111,877	1,119	8,702	7,458	2,486	3,978	3,729	2,983	9,945	4,972	157,249
Aug	109,814	1,098	8,541	7,321	2,440	3,905	3,660	2,928	9,761	4,881	154,350
Sep	108,110	1,081	8,409	7,207	2,402	3,844	3,604	2,883	9,610	4,805	151,954
Oct	100,254	1,003	7,797	6,684	2,228	3,565	3,342	2,673	8,911	4,456	140,912
Nov	77,180	772	6,003	5,145	1,715	2,744	2,573	2,058	6,860	3,430	108,481
Dec	72,361	724	5,628	4,824	1,608	2,573	2,412	1,930	6,432	3,216	101,707
<b>Total</b>	<b>1,209,701</b>	<b>12,097</b>	<b>94,088</b>	<b>80,647</b>	<b>26,882</b>	<b>43,012</b>	<b>40,323</b>	<b>32,259</b>	<b>107,529</b>	<b>53,764</b>	<b>1,700,302</b>

**Figure II-J – Microgrid PV Fleet Electric Production**

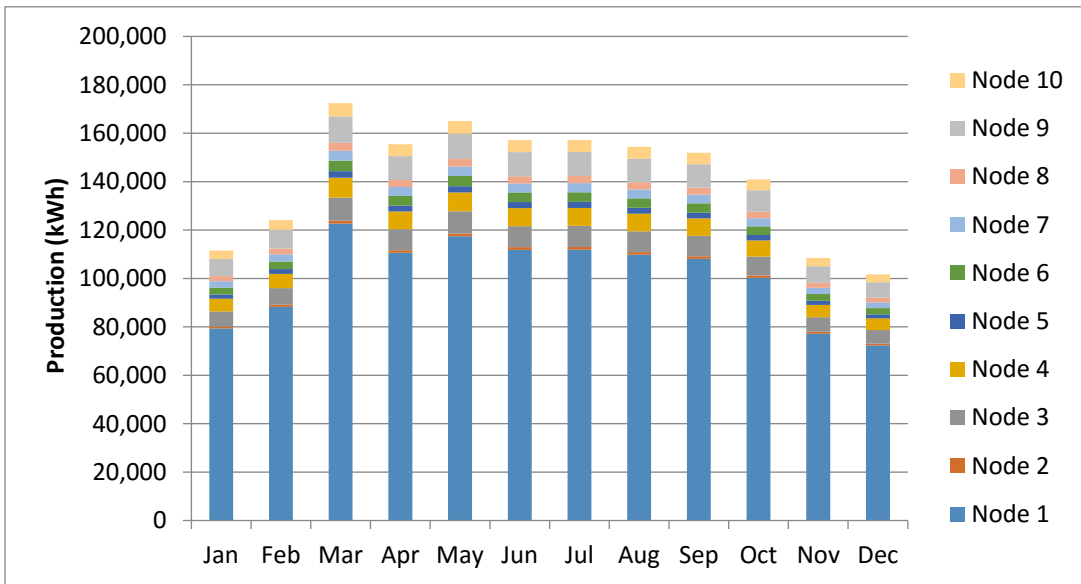
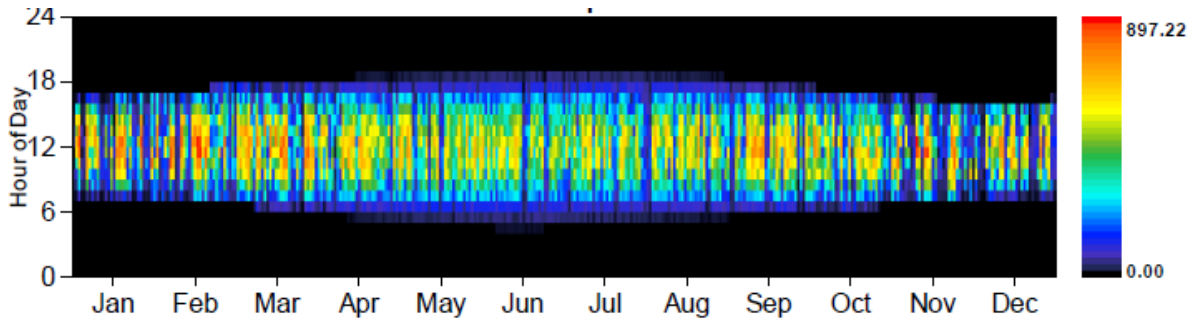

Figure 13 presents the hourly operation of the PV in node 1 in the form of a heat map. This representation demonstrates how the PV units operate during hours of sunshine with maximum production in the middle of the day, ramping up in the mornings and ramping down in the afternoon hours. This also illustrates the trend of narrower daily bands of production in the winter and then expanding to maximum production in the summer.

**Figure II-K – Node #1 PV Operational Summary**



**Energy Storage Systems**

Energy storage in a microgrid can improve the payback period for the whole system by enabling an increase in the penetration of renewable energy sources, shifting the energy produced by PV, enabling peak load management, managing PV intermittency, providing volt/VAr support, and supporting island mode transitions. The technology specified for the Warwick microgrid is Lithium Ion (Li-ion) batteries, which have a fast reaction response to changes in load, a fairly small footprint and a relatively high round trip efficiency. Li-ion batteries have several unique operational characteristics:

- The usable energy capacity is between a 15% and 95% State of Charge (SOC)
- The life of the batteries are impacted by temperature and charge rate
- Most systems are capable of approximately 3,000 deep discharge cycles (+/- 80% SOC cycles)
- Most systems are capable of more than 100,000 shallow discharge cycles (+/- 15% SOC cycles)
- The batteries are at a high risk of failure if the system is discharged to a 0% state of charge
- The systems typically have different rates (kW) for charge and discharge
- Most Li-ion systems have accurate methods of determining the system SOC
- Typical power electronic systems provide multiple modes of operation
- Systems are typically capable of four quadrant operation

**Benefits of Energy Storage**

- Reduces utility costs and improves economic competitiveness
- Increases power reliability and self-sufficiency
- Reduces GHG emissions and other pollutants
- Reduces demand for imported energy supplies
- Supports system with a high level of renewable energy penetration
- Based on a suite of proven, commercially available technologies for a variety of applications
- Competitive market for hardware and installation services
- Provides multiple functions and benefits to the microgrid:
  - Peak Load Management
  - Load Shifting
  - Frequency Regulation
  - Reactive Power Support

- PV Support
- Demand Response
- Energy Arbitrage
- Backup Power

Figure II-L presents examples of energy storage installations for the technologies considered for the proposed microgrid.

**Figure II-L – Example ESS Installations**



25 kW / 75 kWh pad mount system

25 kW / 50 kWh pad mount system with storage in underground vault

Multiple 5 kW / 12 kWh systems

**Energy Storage Approach**

- Co-Locate with PV systems on the customer-side of the meter to support resiliency
- Install indoors or outdoors (indoor installation better for resiliency)
- Maximize functional benefits for the microgrid
- Support microgrid operations when the electric grid is not available along with CHP, energy storage, and building load control

## ESS in the Microgrid

Table 13 summarizes the ESS components by node of the microgrid. The layout diagram and single-line diagram in the appendix provide details regarding size and location of the planned ESS system.

**Table II-M - Microgrid ESS Resources by Node**

Node	Battery Energy Storage		
	Quantity	kW	kWh
1	4	35	70
2	1	5	10
3	1	10	20
4	1	5	10
5	1	5	10
6	1	5	10
7	1	5	10
8	1	5	10
9	1	5	10
10	1	5	10
<b>Total</b>	<b>13</b>	<b>85</b>	<b>170</b>

Unlike the other microgrid resources, the ESS both consumes and produces energy. When properly used, the net energy consumed is very small. The annual operation of the Node 3 ESS is presented in Table II-N, presenting both the charge and discharge modes of operation. The net value is positive which takes into account the operational losses for the systems.

**Table II-N - Microgrid ESS Operation – Node 3**

Month	Charge	Discharge	Net
	(kWh)		
<b>Jan</b>	546	501	45
<b>Feb</b>	575	525	50
<b>Mar</b>	512	460	53
<b>Apr</b>	511	470	41
<b>May</b>	485	446	39
<b>Jun</b>	499	459	40
<b>Jul</b>	235	220	15
<b>Aug</b>	240	217	23
<b>Sep</b>	94	86	7
<b>Oct</b>	518	477	41
<b>Nov</b>	524	482	42
<b>Dec</b>	561	516	45
<b>Total</b>	<b>5,299</b>	<b>4,859</b>	<b>440</b>

**Figure II-M – Microgrid ESS Operation – Node 3**

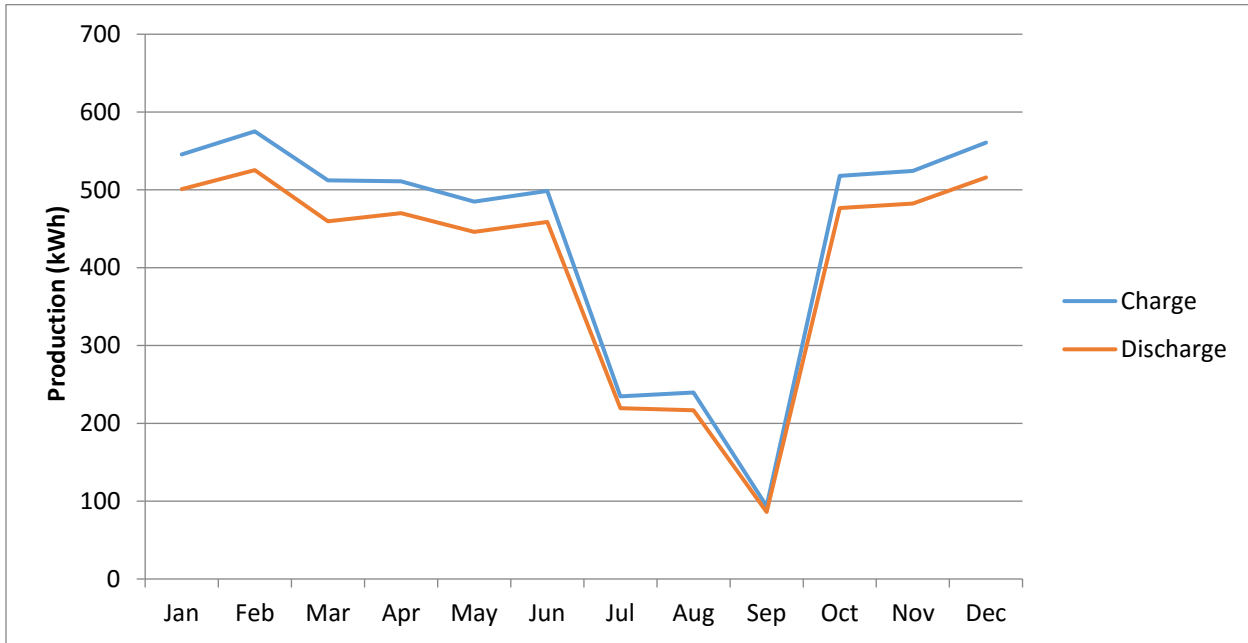
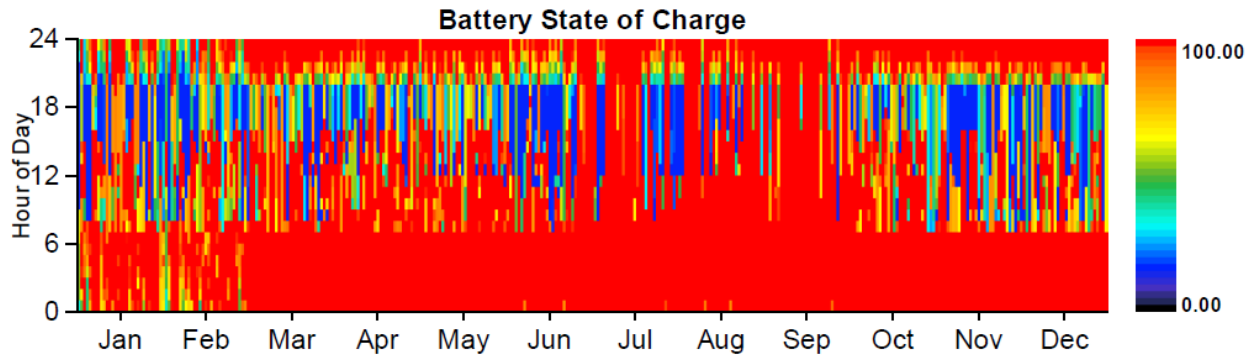

Figure II-N presents the hourly operation of the ESS in node 3 in the form of heat map. This representation demonstrates how the ESS units operate. Typically, the units are charged to a high SOC to start each day and are operated during normal business hours. The operations represent PV intermittency support, PV load shifting and peak shaving (to manage utility imports). The size of the ESS units is required to support operations during the summer months where as they are not used during the late winter and spring months of the year.

**Figure II-N – Node #3 ESS Operational Summary**



**Portfolio of Microgrid Distributed Energy Resources**

The design for the Warwick microgrid incorporates resources into non-intrusive areas available at critical facilities. Refer to the microgrid layout diagram (Appendix A) and one-line diagram (Appendix B) for general locations of resources.

The modeling of this microgrid indicates that the most economical total onsite DER generation requirement is in the range of 80 to 86% by energy (kWh) in grid-connected mode. Since specific DER sizes are discrete capacities, the matching of generation to load is imprecise, hence the range 80 to 86% by energy.

The electrical and thermal demand can also be modulated to meet total available DER production in a range of timeframes, from a few minutes to several hours. This modulation of load may have some comfort impacts, but will not impact mission critical functions within the critical facilities of the microgrid. In grid-connected mode, load modulation is not expected to take place unless driven by economic optimization, within the customer’s stated objectives. In island mode, reliability and resiliency are the primary objectives, and load modulation may occasionally be used at certain times of the most energy-intensive days. If additional load modulation is needed, then critical facilities will be affected, but not in a way that would result in a material impact on the mission of that facility.

Upon loss of the grid, a “sliding scale” of importance of facilities in island mode will be used to make decisions about load modulation. During the first hours of a grid outage from a major storm, facilities providing emergency services (police, fire, emergency medical, hospital, etc.) will be prioritized. However, for extended outages, such as those during a major storm, other facilities may become “critical” with time. For example, by the second or third day, the need for medications and food may drive groceries and pharmacies onto the “critical” list. By the fourth day, gasoline for home generators, mobile phone charging, cash, and emergency shelter may become very important to enable residents to shelter in place, elevating gas stations, ATMs, and public shelters onto the “critical” list.

The proposed microgrid design is based on a portfolio of resources, including base generation driven by fuel delivered over resilient underground lines, PV operating when the sun is available (requiring no delivery), and energy storage systems (ESS) that store excess PV production for later use. Unlike an emergency diesel generator, this structure has no duration limit.

This microgrid design supplies all critical loads throughout the duration of a grid outage. In addition, some non-critical loads may continue to operate throughout the event when microgrid generation resources produce more energy than is required to serve the critical loads. Preliminary analysis suggests the sum of critical load and non-critical load served in island mode will be about 80% of the normal total load.

Since the microgrid design eliminates the need for temporary generation such as backup diesel generators, it will protect the Warwick facilities covered by the microgrid from the need to shared fuel and equipment with other communities, as is common during extended utility grid outages.

### **Microgrid DERs Resiliency**

Section I summarizes the resiliency risk profile for various forces of nature to inform the microgrid design. This profile was evaluated in the following areas, with the associated design emphasis results:

1. Wind / Tornado – the design of the DER structures (base foundations, enclosures, and connections) for distributed generators, fuel cells, CHP, outdoor energy storage, solar PV panels (hail rated) and racking, and electrical and thermal distribution equipment will withstand Category F2 wind speeds for this area. Installation of energy storage systems will be inside interior building electrical or mechanical rooms wherever possible.
2. Rain / Flooding / Hurricane – the design of the structures (base foundations, enclosures, and connections) for distributed generators, fuel cells, CHP, outdoor energy storage, solar PV panels (hail rated) and racking, and electrical and thermal distribution equipment will withstand Category 4 Hurricane (Staffer-Simpson scale, same maximum wind speed as the Category F2 tornado on the

Fujita scale). In addition, the height of the base foundation for outdoor units is designed to assure the equipment is 1 to 1.5 feet above the 100-year flood plain level. Installation of energy storage systems will be inside interior building electrical or mechanical rooms wherever possible.

3. Earthquake – the design of the structures (base foundations, enclosures, and connections) for distributed generators, fuel cells, CHP, outdoor energy storage, solar PV panels (hail rated) and racking, and electrical distribution equipment will withstand seismic event magnitude 6.9 (Richter scale), or 100-year local seismic event, whichever is lesser. Due consideration is given to the design to overhead risk from buildings and other structures located above the microgrid equipment.
4. Extreme Heat – the design the structures (base foundations, enclosures, and connections) for distributed generators, fuel cells, CHP, outdoor energy storage, solar PV panels (hail rated) and racking, and electrical distribution equipment will withstand 125oF (50oC) continuous operating temperatures. Where equipment enclosure temperatures are expected to exceed these temperatures for more than 10 minutes, space cooling is added.
5. Cold / Ice – the design of the structures (base foundations, enclosures, and connections) for distributed generators, fuel cells, CHP, outdoor energy storage, solar PV panels (hail rated) and racking, and electrical distribution equipment will withstand 15oF (-24oC) continuous operating temperatures. Where equipment enclosure temperatures are expected to exceed these temperatures for more than 10 minutes, space heating is added. Enclosure design includes mitigation of ice formations that block airflow.

While deep snow on PV arrays can affect production, the typical effects are not as severe as one might guess. The performance criteria for snow cover on PV panels are based on annual loss of energy generation. A study published at Sandia National Laboratory, conducted by Queens University and Calama Consulting in Canada, on a set of PV arrays totaling 8 MW in Kingston, Ontario, Canada using 2010-2012 data (annual snowfall 21 inches) shows that snow affects about 1 to 3% annual production loss – similar to the annual production loss from sand and dust in San Diego, Calif.

**Figure II-O – PV Impedance from Snowfall**

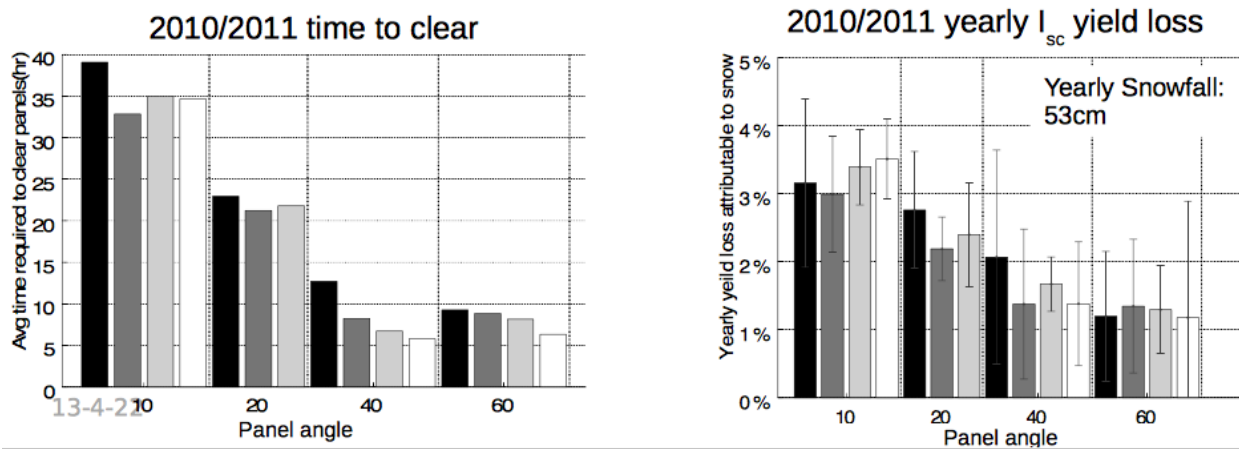

The first graph in Fig. II-O shows the time required to clear the snow. The second graph shows the yield loss rate for having the snow in place for the duration of the first graph. Both are based on panel angle.

## Reliability of Fuel Sources

Microgrid installations of natural-gas-fired generation systems at multiple locations provide opportunities to improve the quality and reliability of gas distribution that will benefit a wide range of customers throughout Warwick.

The natural gas network is considered an uninterruptable fuel supply for the community in the face of major storms because:

- (1) there are multiple network sources of natural gas
- (2) the actual natural gas network load decreases in a major storm because the non-critical loads are not operating
- (3) there is no history of loss of service in past major storms

In addition, interruptible service is a financial construct, not a technical limitation. Home heating is considered the highest priority for continuity of supply in the face of challenges to the natural gas network. Since this microgrid will use natural gas for CHP (heating of critical facilities), it will be given the highest priority for continuity of supply in the face of a major storm.

The operation of the microgrid will minimize the use of existing emergency diesel generators, and extend the typical three-day onsite fuel load for the emergency diesel generators to one week.

## Microgrid DER Capabilities

As Section I explains in detail, the Warwick microgrid design is focused on the development of an overall energy strategy that incorporates both demand-side management and new distributed generation resources to support the microgrid's operational objectives (*see Section 1.1*).

### 2.4 Electrical and Thermal Infrastructure Characterization

The proposed microgrid design employs underground cabling to support each microgrid node in key areas where it is cost effective for the overall project. While this greatly improves resiliency within a microgrid node, the cost of the underground cabling limits the reach of the node. The utility feeders are mainly overhead lines, which cannot be relied upon in the event of a major storm. The same general protection schemes are employed in each microgrid node as are used in utility distribution networks (see Microgrid Protection Scheme below). Some pole-top transformers will be replaced with pad-mount distribution transformers, and additional isolating switches and breakers will be added at the PCC as described above. Four electrical circuits at 4.8 kV supply electricity to the community. Node 1 is supplied by 2 circuits of which one of them also supplies the fire stations. A third circuit supplies electricity to the remainder of the planned nodes. In engineering and deployment phases, the design team and Orange and Rockland's engineering team will refine the anticipated microgrid design.

The existing thermal infrastructure consists mainly of hot water systems. If there is a steam system, the microgrid CHP system will not attach to it because the output temperatures of the natural gas engines do not meet the quality standards for a steam system. The CHP connections to the hot water systems are installed in parallel with existing boiler(s), and fed into the supply and return headers.



**Table II-O - Microgrid Electrical and Thermal Infrastructure Plan**

<b>Infrastructure</b>	<b>Class</b>	<b>Associated Device</b>	<b>Comment / Description</b>
<b>4.8 kV, 3 phase Underground Cabling</b>	New	Node 1	New interconnection of multiple electric accounts within the node
<b>PCC (All Nodes)</b>	New	4.8 kV line to distribution transformer	Transition from overhead to underground
<b>4.8 kV Transformers</b>	Updated	Critical Facilities	Conversion from pole-top to pad mount
<b>Synchronizing Switches</b>	New	CHP	Each CHP at a critical facility will require a synchronizing switch with protection to enable remote synchronization with the microgrid bus
<b>M, C, P</b>	New	All resources	Monitoring (sensing), Control, and Protection relays for proper management of resources in all modes
<b>Automatic Transfer Switch</b>	Existing	Emergency Generators	All emergency generation (diesel or gas) have automatic transfer switches installed in critical facilities. This will remain unchanged.
<b>HW Supply Connection</b>	New	CHP & heating	Tie-in from CHP to facility thermal loop for each facility with new CHP
<b>HW Return Connection</b>	New	CHP & heating	Tie-in from CHP to facility thermal loop for each facility with new CHP

**Infrastructure Resiliency**

The electrical infrastructure currently consists of overhead distribution lines with pole-mounted transformers. The microgrid design calls for one or more underground 4.8 kV circuits to be established at strategic locations, most notably within Node 1 along Main Street. During engineering phases, the

project team will work with Orange and Rockland to determine the most cost-effective approach for organizing and installing new underground segments. In the other nodes, the microgrid distributed energy resources will be behind the meter of a single customer, and the node design will support standalone island operation when the grid goes down. The discussion of resiliency of resources to forces of nature in section 2.3 is relevant to electrical and thermal infrastructure as well. Outdoor switches for the underground electric distribution network will be installed in enclosures in in-ground vaults. The natural gas infrastructure relied upon for resiliency is underground, which greatly reduces the risk of damage from forces of nature.

### **Point of Common Coupling Design Detail**

The process of islanding a microgrid can create instability (in the form of an electrical transient) and added risk to operations. To minimize this, the design incorporates a Point of Common Coupling structure will help to protect the microgrid from danger (*see Fig. I-E*). This structure, coupled with additional analysis compliant with IEEE 1547.4, enables the utility-controlled breaker or switch to immediately open (frequency = 59.3 Hz) on loss of the grid. The microgrid managed synchronizing breaker will remain closed for a few more milliseconds until microgrid frequency reaches 57.0 Hz. Since the inverters and generator controls are keying off the synchronizing breaker, these few additional milliseconds enable the energy storage and power electronics to better manage the transient as the microgrid resources pick up the portion of the load served by the utility grid just before the grid was lost. When, or if, the frequency dips to 57.0 Hz and the synchronizing breaker opens, the microgrid moves into island mode. The microgrid controller will adjust all microgrid resources for island mode operational and performance objectives.

When the island transition is too small to generate instability (such as during an intentional island operation), the microgrid controller will open the synchronizing breaker when voltage, frequency, and phase angle are matched and stable across the breaker.

The microgrid design ensures a seamless transition back to the grid when power is restored. The microgrid controller (and/or operator) will connect with the utility distribution management according to all appropriate protocols, safety mechanisms, and switching plans.

The sequence of events for transitioning from an island mode to grid-connected mode is formed in accordance with the EPRI/ORNL Use Case 5. A summary of the transition plan is as follows:

- Utility determines it is acceptable for the microgrid to reconnect to the grid and closes the utility controlled breaker (see PCC figure above).
- Microgrid controller senses voltage, frequency, and phase angle on the bus between the utility controlled breaker and the microgrid synchronizing breaker. The controller also senses voltage, frequency, and phase angle within the microgrid.
- Microgrid controller (and/or operator) decides to reconnect the microgrid to the utility grid.
- Microgrid controller adjusts controllable resources and loads to match voltage, frequency, and phase angle across the microgrid synchronizing breaker. This minimizes differences and power flows.
- When matched, the microgrid controller gives a “permissive to close” signal to the microgrid synchronizing breaker.
- The synchronizing breaker does its own checking of voltage, frequency, and phase angle matching, and closes when matched.
- The microgrid controller places some microgrid load on the utility grid, and re-optimizes for economics and emissions reduction.

## Microgrid Protection Scheme

The Microgrid protection scheme is similar to a standard utility distribution level protection scheme. However, since power flow is two-way in the microgrid and more actively managed, a more aggressive protection scheme is required. At every site where a resource interfaces with the microgrid (inverter, breaker, controller, etc.), the microgrid will feature a protection envelope with the following components:

- Underfrequency
- Undervoltage
- Overfrequency
- Overvoltage
- Phase to phase fault
- Phase to ground fault

Because of the two-way power flow within the microgrid, no reverse power trip protection is applied within the microgrid, except at the utility-side breaker (switch) at the PCC.

In addition, real-time droop algorithms and phase angle measurements are utilized to mitigate protection requirements. For example, with voltage-source energy storage, continuous phase angle correction is applied, which also enables power factor correction.

## 2.5 Microgrid and Building Controls Characterization

### Microgrid Control Architecture

A common challenge for community microgrid design is that critical facilities tend to be distributed throughout the community rather than located in convenient clusters. To maximize the economics, reliability, and emissions reduction potential of the community microgrid, the microgrid controller architecture must have the capability to coordinate and control different groups of resources as well as provide control for localized operations.

The team has developed a project concept for the community microgrid that allows for simultaneous control of multiple microgrids in the community as well as coordination with the local utility. Specifically, the solution includes local controllers in each microgrid part as well as a hosted controller in the Microgrid Network Operations Center (NOC) that can operate each microgrid part separately or collectively. (See Fig. I-G).

In the grid-connected mode, the primary operations will focus on maximizing economic benefits and minimizing emissions across all the microgrids within the community. In some cases, the aggregation of the microgrid resources can be operated to support utility firming requests or ISO ancillary services, such as demand response and frequency regulation. However, during a reliability event, the operation of each individual microgrid controller will focus only on the load and generation assets within its control. The local controller will transition to island mode while maintaining proper voltage and frequency.

### Control Capabilities and Services

The microgrid controller will have an active management and control architecture that supports the 10 EPRI/ORNL Use Cases:

1. **Frequency control:** In normal operations, the microgrid may not have enough resources to affect frequency on the grid. It could participate in the ancillary services markets by increasing output to

support the frequency in the local grid, but total impact would be small. Nevertheless, the system will monitor frequency along several thresholds – providing a discrete high-low range; the system will detect if frequency is out of range and respond by taking resources off-line, or dispatch other resources to manage frequency. Also, the system will analyze data to detect subtler trends that do not exceed thresholds, but provide evidence of a possible problem.

2. **Voltage control:** In both grid-connected and islanded modes the voltage control application will be used to provide stability to the microgrid and connected circuits. Voltage control leverages line sensing and metering to provide control actions when necessary. This application will take into account traditional volt/VAr instruments such as tap changers and cap banks along with inverter-based resources, which should provide a greater degree of optimization.
3. **Intentional islanding:** For each microgrid node, the islanding process will be semi-automatic so that a utility operator or local energy manager will be able to move through each step before opening the PCC. The utility operator will provide the appropriate permissives for opening the PCC. The local microgrid controller for each microgrid node will be responsible for setting the voltage source and load-following resource.
4. **Unintentional islanding:** The designed PCC structure (see Figure 18), coupled with additional analysis compliant with IEEE 1547.4, enables the utility-controlled breaker or switch to immediately open (frequency = 59.3 Hz) on loss of the grid. The microgrid managed synchronizing breaker will remain closed for a few more milliseconds until microgrid frequency reaches 57.0 Hz. Since the inverters and generator controls are keying off the synchronizing breaker, these few additional milliseconds enable the energy storage and power electronics to better manage the transient as the microgrid resources pick up the portion of the load served by the utility grid just before the grid was lost. When, or if, the frequency dips to 57.0 Hz and the synchronizing breaker opens, the microgrid will move into island mode. The microgrid controller will adjust all microgrid resources for the new state and island performance objectives.
5. **Islanding to grid-connected transition:** As with intentional islanding, the utility operator will provide the appropriate permission to close in the PCC. The local microgrid controller will support the reconfiguration of each dispatchable resource.
6. **Energy management:** The microgrid design incorporates a portfolio of resources. The EPRI Use Case takes a traditional energy management approach – economic dispatch, short-term dispatch, optimal power flow, and other processes typical in utility control room environments. The microgrid controller will have corresponding applications that manage a set of controllable generation and load assets. Within that portfolio, the system will also optimize the microgrid based on load forecast, ancillary services events, changes in configuration, outage of specific equipment, or any other kind of change to determine the optimal use of assets 48 hours ahead.
7. **Microgrid protection:** The microgrid controller will ensure two primary conditions. The first is that each protection device is properly configured for the current state of the microgrid, either islanded or grid-connected. The second condition is that after a transition, the microgrid controller will switch settings or test that the settings have changed appropriately. If the test is false in either condition, the controller will initiate a shutdown of each resource and give the appropriate alarm.
8. **Ancillary services:** The controller will provide fleet control of the nested microgrid parts. Specifically, the utility operation will have the ability to request and/or schedule balance up and balance down objectives for the fleet. The cloud-based controller will take the responsibility to parcel out the objectives for each microgrid part based on the available capacity.

9. **Black start:** The local microgrid controller will provide a workflow process for restarting the system. Each microgrid part will have a unique sequence of operations for predetermined use cases. One objective will be to provide this function both locally and remotely to meet the reliability requirements of the overall design.
10. **User interface and data management:** The solution provides local controllers in each microgrid part as well as a hosted controller that can operate each microgrid part separately or collectively. The primary actors are the utility operator, local energy managers, maintenance personnel, and analyst. The user experience for each actor will be guided by a rich dashboard for primary function in the system around Operations, Stability, Ancillary Services, and Administration.

In addition, the microgrid controller will:

- Forecast variable aspects: load, wind, solar, storage
- Dispatch of DER to maximize economic benefit
- Continuously monitor and trend health of all system components
- Take into account utility tariffs, demand response programs, and ancillary service opportunities
- Understand operational constraints of various DER and vendor-specific equipment
- Interface to local utility
- Meet rigid and proven cyber security protocols

Ultimately, the control system will perform all of the functions above to continuously optimize the operation of the microgrid for economic, resiliency and emissions performance.

## 2.6 Information Technology (IT)/Telecommunications Infrastructure Characterization

### IT Infrastructure

A microgrid controller design needs to be reliable and have redundancy comparable to the other microgrid resources. A standard controller approach such as central controller or programmable logic controller (PLC) design will therefore not be sufficient. The architecture must support the capability to interface with field devices, provide a platform for communications and data management, provide for both local and remote operator access, have a data historian, and provide for applications to meet the microgrid Use Cases highlighted above. A conceptual controller topology is presented in Fig. II-P.

**Figure II-P: Conceptual Microgrid Controller Topology**

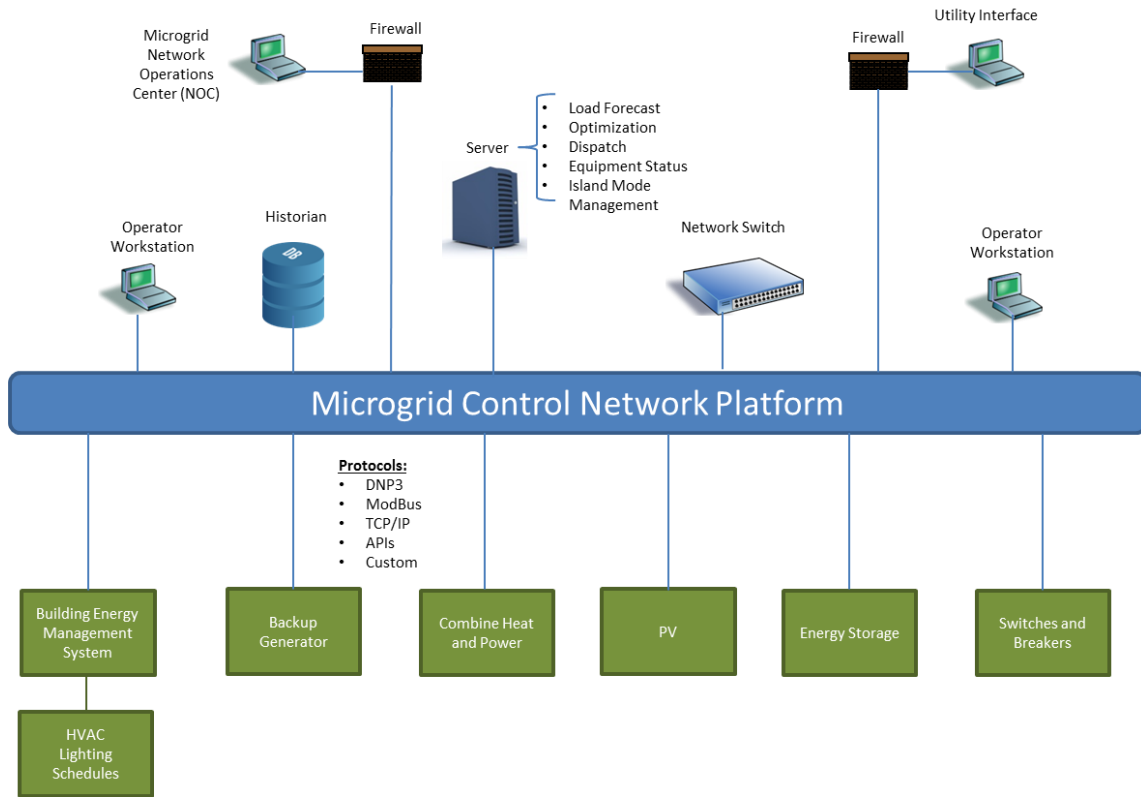

To support the community node approach, the microgrid control scheme will provide for a secure external access to the NOC that can coordinate the various nodes within the community. In addition, remote access to the utility will be provided to inform them and their distribution operators of the microgrid status and to communicate protection relay permissives for the island-mode transitions. The system will be designed so the core control functions are located within the microgrid and so that loss of communication with the NOC will not significantly impact the local operations of any node. The NOC monitors equipment performance and coordinates across nodes. In the event of an outage, all control will move to local controllers and focus on site specific optimization and operations.

The microgrid controller will leverage existing equipment to the greatest extent possible. This will include building energy management systems, backup generators, and local area networks. For the purposes of reliability and security, the microgrid control system will consist of new and independent infrastructure.

**Telecommunications Infrastructure**

Each microgrid node will have a wireless LAN specific to the microgrid, powered by microgrid resources, and extended to every resource, device, sensor, and load interface (e.g., building management system). This communications infrastructure will be designed with dual-redundant access points to assure reliable onboard communications.

The architecture will conform to requirements established by the Smart Grid Interoperability Panel (SGIP) and generally accepted communications protocols, such as ModBus (TCP/IP), DNP3 (TCP/IP), and IEC61850, as well as field networks for buildings such as LonWorks and BACnet. ModBus will be used

throughout the microgrid nodes for communications since it is currently the most prominent communications protocol within the DER and inverter community. Communications with the utility distribution management systems will use DNP3, since that is the prominent protocol used by the utility industry.

In addition, to assure security and continuity of operations in all modes, the architecture and design of the microgrid controls IT and communications will adhere to NIST IR 7628, "Guidelines for Smart Grid Cyber Security." Finally, new IT/telecommunications infrastructure will be installed to secure the microgrid controls network separately from existing IT and communications systems at the facilities.

### **Communications – Microgrid and Utility**

Communications between the microgrid and the utility will occur in two forms: (1) utility distribution management system (DMS) will interface with the microgrid controls for monitoring and managing the PCC utility-controlled isolating switch and microgrid-controlled synchronizing breaker, and (2) a dashboard served by the microgrid controls to the utility via the internet will give the utility insight into the day to day operations of the microgrid.

In accordance with the EPRI/ORNL Microgrid Use Case 4, the microgrid will transition into island-mode operations upon loss of communications between the utility DMS and the microgrid, assuming loss of grid. No specific microgrid action will be taken on loss of the utility dashboard service via the Internet.

The microgrid control system will be local to the microgrid node in a secure, conditioned space, (e.g., electrical room) in one of the critical facilities within the microgrid node. This assures that real-time control of the microgrid resources and loads will be maintained in the event of a loss of communications with the utility DMS and Internet services. Although economic optimization will be reduced for a period of time, the reliability and resiliency optimization will be maintained, because those algorithms are in the microgrid control system local to the microgrid node and do not require offsite communications to function.

The onboard communications within the microgrid LAN will be a dual-redundant architecture, where every LAN access point is backed up by another access point.

## Section III:

### Task 3: Commercial & Financial Feasibility

Section III describes the preliminary assessment of commercial and financial feasibility for the proposed Warwick Microgrid in Orange County, N.Y. In sum, the project team’s iterative modeling and analysis yielded an economically and technically viable microgrid design. The team believes the Warwick microgrid will serve as a leading example for New York, and will be beneficial and replicable for numerous communities across the state and beyond.

The proposed Warwick Microgrid business model serves four strategic goals: (1) Improve the resiliency of services that are critical to the health, safety, and vitality of the community; (2) Increase the community’s use of local resilient renewable energy assets; (3) Reduce the community’s fossil energy consumption and related environmental footprint; and (4) Support future economic development and growth by modernizing community energy infrastructure.

The proposed approach to commercial and legal structures incorporates lessons learned from the project team’s microgrid experience and industry best practices. The proposed approach also aims to support New York State initiatives to foster innovation and competition in energy services, including the Reforming the Energy Vision (REV) proceeding.

This section is organized in accordance with the sub tasks outlined for Task #3 in the NY Prize Feasibility Assessment statement of work, with introductory summary and background added to establish the structural context and objectives for feasibility analysis.

*Business model summary:* The Warwick Microgrid (“the microgrid”) is designed to address the community’s critical resiliency priorities while also supporting its renewable energy and environmental objectives. The proposed business model uses a P3 ownership structure to support capital investments and operational capacities necessary to achieve the community’s strategic goals. The microgrid is envisioned to provide service for the Warwick community<sup>6</sup> via an SPE established to execute the project strategy.

*Transactive energy study potential:* The team’s design and planning process included consideration of whether and how the proposed microgrid could serve as a demonstration platform for studying transactive energy (TE) micro-market dispatch of distributed energy resources (DER), and questions such study would address. Accordingly, where appropriate, Section III includes notes addressing TE study potential. In general, the team determined that the proposed Warwick Microgrid could, in principle, provide a platform for a pilot project to demonstrate TE micro-markets, especially if Warwick Microgrid critical facility nodes were supplemented with other DERs as part of an integrated community energy system. (See Appendix D – *Optional Multi-Tiered Energy Services Model*). Community stakeholders do not support such expansion at this time, and so a TE micro-market demonstration is not anticipated for the Warwick Microgrid.

---

<sup>6</sup> The term “Warwick community” refers collectively to the Town of Warwick, the Village of Warwick, and effectively all energy customers and stakeholders in and around Warwick, N.Y.



### 3.1 Commercial Viability – Customers

Through an iterative process of community outreach and planning, the team identified customers in four categories of viability (*grades A through D; see Table III-A*). All major customer facilities modeled for the Task 2 report are graded as either High or Moderate viability, supporting a strong likelihood of onboarding all identified customers.

**Table III-A: Customer Viability Matrix**

CUSTOMER	Viability Grade (A-F)	Viability Rating (1-5)	Economic	Technical	Legal & Market	Process	Other
<b>CRITICAL / VITAL FACILITY CUSTOMERS</b>							
Town of Warwick / Police, command center, and public shelter	B	3.68	4	2	3	3	2
Village of Warwick / Water system and command center	B	3.61	3	1	3	4	4
Bon Secours Charity Health System / St. Anthony's Hospital and Assisted-Living Facilities	A	4.03	3	3	3	3	4
Warwick Fire District	B	2.82	2	1	3	1	4
Warwick Ambulance Corps	B	2.88	2	1	3	1	4
<b>AVERAGE †</b>	<b>B</b>	<b>3.40</b>	<b>3</b>	<b>1</b>	<b>3</b>	<b>2</b>	<b>4</b>
<b>ECO / TECHNICAL CUSTOMERS</b>							
CVS Pharmacy*	C	2.67	2	1	3	0	4
Alteva - Warwick Valley Telecom*	C	2.64	1	2	3	0	4
Sunoco Gas Station*	C	2.74	1	2	3	1	4
[Commercial properties downtown]*	C	2.68	1	2	3	1	4
<b>AVERAGE</b>	<b>C</b>	<b>2.68</b>	<b>1</b>	<b>2</b>	<b>3</b>	<b>0</b>	<b>4</b>

*Notes:*

Viability grade (A to B=High; B- to C=Moderate; D=Low; F=Not viable)

Factor score: -4 strongly detrimental; -3 detrimental; -2 somewhat detrimental; -1 slightly detrimental; 0 neutral; 1 slightly supportive; 2 somewhat supportive; 3 supportive; 4 strongly supportive

\* Customer not yet fully engaged; some factor scores uncertain

† Average viability of customers considered strongly supportive or indispensable for project objectives

(See also Appendix C: Customer Viability Methodology)

Some viability factors can represent “deal-killer” thresholds. For example if a customer is Not Viable in terms of technology solutions, then that customer would be deemed Not Viable without finding a viable technical solution. Customers determined to be Not Viable were omitted from the proposed microgrid during Task 2 and Task 3 analysis.

In the current phase of study, the proposed microgrid omits Warwick Central School District facilities, because the school district entered a long-term agreement with ConEdison Solutions to offset substantially 100 percent of its electricity consumption from a remote net-metered solar project outside

the microgrid area. Alternative approaches providing resilient energy services for school district facilities were examined and deemed not viable as microgrid customers.

Options for providing additional services as part of an integrated community energy system were considered, and deemed optional for further consideration in subsequent project phases. (See Appendix B).

### 3.1.1 Commercial terms and relationships

A. *Energy services agreements:* The study team considered commercial contracting and transactional options for meeting community objectives, and found that the most applicable options involve uniform, long-term, bilateral agreements to provide resilient energy services and sustainable resources. Such commercial structures allow the Warwick Microgrid to closely match asset investments and energy service capacities to the needs and wants of customers, while also establishing a financeable business model enabling access to sources of low-cost financing. Exemplary models are drawn from ESCO and energy savings performance contracting (ESPC) practices.

Microgrid customers and the P3 will enter long-term (25-year) service agreements for operations to meet microgrid objectives.

- Microgrid energy services: The microgrid P3 will serve as the Warwick community’s ESCO, arranging for full-scope energy supply, storage, efficiency, and load management necessary to provide resilient energy services for microgrid customers throughout the contract term.
- Microgrid Platform/Distribution Service Platform Provider (DSPP): The microgrid P3 will provide electricity control and transport services for microgrid customers under transferable uniform service agreements, separate from energy services agreements.

- B. *Partner and vendor agreements:* The Warwick Microgrid P3 will engage various services, technology, and equipment vendors as:
- a. Partner: Along with third-party entities, the P3 may co-own assets and obligations for performing contracted services.
  - b. Contractor: The P3 would contract with vendors and service companies to provide a range of products and services necessary for meeting the P3’s objectives. These services may include, for example, design engineering, capital equipment, installation, operations and maintenance, energy supply and delivery, finance, administration, management, and customer service.

- C. *TE study notes:*
- a. The proposed approach to commercial terms and relationships supports potential to further understand how TE micro-markets may yield more cost-effective DERs. TE works with bilateral transactions among market participants (“counterparties”). The classes of counterparties in TE are:
    - i. Energy services counterparties: The parties that consume, produce and store energy (both internal microgrid parties and external parties)
    - ii. Transport services counterparties: The parties that provide energy transmission/transportation and distribution services (resilient or otherwise)

- iii. Intermediaries: the parties such as the microgrid P3 or other ESCOs or aggregators that facilitate both long-term contracts and spot transactions among energy services counterparties to balance supply and demand, both long-term and operationally in both islanded and connected microgrid operations.
- b. Each energy services counterparty could make its own investments in generation, storage, and energy use devices, or it would transact with other counterparties to meet its needs. Operationally, each counterparty either would use its own generation and storage or would buy from other counterparties as needed. The Warwick Microgrid would serve as an automated market-maker intermediary, continually posting buy-and-sell tenders with forward prices that counterparties can use to efficiently self-dispatch while helping to balance supply and demand.
- c. Counterparties could chose to invest in resilient devices and transact only with counterparties providing resilient energy services over resilient transport. Additionally they could select the portions and types of green energy resources they want to invest in or secure by contract.
- d. Microgrid customers would enter long-term contracts for assured access to the resilient elements of the microgrid, and could also rely on spot-market transactions for some portion of resilient energy services.
- e. Any counterparty could choose to buy and sell directly with internal and external parties (when connected) or with an ESCO or aggregator.
- f. Any counterparty could choose to sell spot ancillary service products to the NYISO.

### 3.1.2 Baseline situation

- A. *Retail utility services baseline:* Orange & Rockland Utilities provides retail electricity and gas distribution services to customers in Warwick, using regulated retail rates. Additionally Orange & Rockland supplies electricity and natural gas using standard offer service rates.
  - a. Microgrid customers pay on average \$0.129/kWh for delivered electricity.
  - b. Orange & Rockland’s electric distribution system in Warwick and surrounding communities relies heavily on overhead lines, exposing critical and vital facilities to substantial T&D outage risks.<sup>7</sup>
- B. *Competitive gas and electricity baseline:* Warwick customers may choose from among a variety of gas and electricity suppliers. Some customers to be served by the Warwick Microgrid currently receive energy services from Direct Energy. Agreements with third-party energy suppliers generally are short in duration, and thus are not expected to prevent contracting with the P3.

### 3.1.3 Utility benefits and ancillary services

The proposed microgrid will support the electric utility in several important ways, including:

- A. *Congestion relief:* The microgrid would help relieve distribution system congestion. By providing additional year-round local generation and load-management capabilities, the microgrid will

---

<sup>7</sup> Approximately 90 percent of end-user outages are attributable to distribution system failures, and not transmission or generation failures. See *Understanding the Cost of Power Interruptions to U.S. Electricity Consumers*, Kristina Hamachi LaCommare and Joseph H. Eto, Lawrence Berkeley National Laboratory, Sept. 2004. <https://emp.lbl.gov/sites/all/files/REPORT%20lbnl%20-%2055718.pdf>

reduce stress on the existing system, potentially allowing the utility to reduce or defer some distribution upgrades, enabling investments in other priority areas.

- B. *Outage response:* During utility grid outages, the proposed microgrid is expected to support Orange & Rockland’s ability to restore service in Warwick and neighboring communities, by freeing utility resources for system restoration priorities affecting other circuits. Additionally, the microgrid may provide black-start support for nearby generation stations, pending coordination with and approval from the utility.
- C. *Distribution system modernization:* The microgrid is expected to modernize and upgrade local distribution systems in the Warwick community. Specifically:
  - a. Microgrid control systems will extend the utility’s capabilities to control and integrate distributed generation and energy storage system (ESS) capacity and resources capable of providing localized support for power quality and distribution grid stability.
  - b. The Warwick Microgrid’s underground cable segments, serving contiguous microgrid customers, will substantially reduce vulnerability to outages caused by local weather events and other assaults on overhead lines.
- D. *Reduced line losses:* By incorporating more local generation assets, the microgrid will reduce line losses associated with long-distance transmission of power required to serve local electricity loads.
- E. *Community microgrid service options:* The project will provide models and options for deployment of microgrids that enhance the resilience of communities served by Orange & Rockland. The proposed P3 will facilitate local public-private investment in local grid modernization, through mutually beneficial cooperation with local communities. This enhanced set of services will strengthen Orange & Rockland’s relationship with community stakeholders and support its market position generally.
- F. *Ancillary services:* Under normal conditions the microgrid’s combined resource portfolio may be operated to achieve economic benefits from dispatching resources in response to ancillary services price signals.
  - a. *Microgrid objectives and ancillary services:* The Warwick Microgrid operator will determine how to maximize economic benefits for aggregated resources, within the constraints of microgrid objectives, as part of ongoing distributed resource planning and operations.
  - b. *Utility and ISO support:* The proposed microgrid solution has the capability to provide important ancillary services to the Orange & Rockland distribution grid, such as demand response, voltage support, and VAR support. Through aggregation of the nodes, the microgrid design supports the provision of ancillary services to the New York ISO. Existing programs include regulation and operating reserve, energy imbalance (using market-based pricing), and the cost-based services of scheduling, system control and dispatch, voltage control, and black start. In addition, the proposed microgrid may improve service reliability, helping the utility to meet regulatory requirements for service reliability improvements without additional capital expenditures.

- c. *TE study notes:* In a TE deployment, the best market-dispatch solution would reduce resource dispatch to trading positions – e.g., certain amounts of energy with given characteristics (most importantly time of delivery), to be served via long-term contracts and spot transactions. In principle, the Warwick Microgrid could serve as a test environment to demonstrate micro-market dispatch of energy resources including functions that provide ancillary services for local distribution system or regional grid operations. Such functions would be most effective if the micro-market included a variety of DERs throughout the Warwick area, and not only those resources installed to serve the community microgrid.

### 3.1.4 Identify microgrid customers

A complete list of all modeled microgrid customers is presented in Table II-A. The Warwick Microgrid is intended to provide services that will directly benefit several customers that operate critical facilities,<sup>8</sup> and to indirectly benefit substantially all customers in and around Warwick.

### 3.1.5 Identify microgrid stakeholders

The Supervisor of the Town of Warwick initiated the NY Prize Stage 1 application response that led to the Warwick Microgrid project proposal. The project team includes a group of major stakeholders in the Warwick community. They include both local municipal entities – the Town and Village – as well as fire and rescue organizations and nonprofit hospital and assisted living facilities. Together these entities provide local emergency management operations, first response and law enforcement, healthcare, and public water supplies for a large township in the Hudson Valley region, centered on a diverse community that totals up to 32,000 residents. Commercial stakeholders include a pharmacy, gas station, bank, and telecom central office. Collectively these facilities provide services critical to the community’s health, safety, and vitality during a long-duration grid outage.

**Table III-B: Warwick Microgrid stakeholders**

Role	Name	Title	Organization
Local Admin	Michael Sweeton	Supervisor	Town of Warwick
Local Admin	Michael Newhard	Mayor	Village of Warwick
Healthcare	Dennis Primrose	Director of Engineering	Bon Secours Charity Health System
Healthcare	Jessica Holler	Facilities Coordinator	Bon Secours Charity Health System
Fire & Rescue	Joe Walter	Chairman	Warwick Board of Fire Commissioners
Fire & Rescue	Frank Corkum	Fire Chief	Warwick Fire District
Fire & Rescue	Frank Cassanite	Captain	Warwick Ambulance Corps
Utility	Joe White	Section Manager – Smart Grid Technology Engineering	Orange & Rockland Utilities

<sup>8</sup> Not all of the community’s critical facilities are included in the microgrid model. Omitted facilities may be eligible for opt-in resilient energy service. Detailed technical engineering and development may yield changes in the proposed microgrid.

### 3.1.6 Stakeholder/customer relationship

Customer organizations (including units of local government) and their representatives are among stakeholders in the Warwick Microgrid project. Among the facilities included in the Task 2 model (approximately 20 facilities with a total 6.5 MW peak electricity load), most are owned and operated by three entities: the Town and Village of Warwick and Bon Secours Charity Health System. Other customers with stakeholder roles include the Warwick Fire District, Warwick Ambulance Corps, and several business owners and developers.

The Town and Village of Warwick assist in outreach and engagement with other groups of stakeholders and customers, including local businesses, nonprofit organizations, and residents eligible to receive microgrid service. Examples include a pharmacy, gas station, bank, and a hospital. Other commercial stakeholders include local developers, contractors, and business owners whose capacity to provide services may benefit from improved local resilience.

Finally, energy business stakeholders include Orange & Rockland Utilities, the distribution utility serving Warwick. As a general matter, microgrid customers are expected to maintain Orange & Rockland accounts while also receiving services from the Warwick Microgrid.

### 3.1.7 Normal operations vs island operation

During normal operations, Orange & Rockland is expected to provide standard retail delivery service to the microgrid point of common coupling (PCC). Approximately 15 percent of annual electricity consumption by microgrid customers will be served by generation from non-resilient energy supplies – *e.g.*, offsite power plants and grid-tied onsite resources. Resilient energy resources – *e.g.*, microgrid-controlled distributed generation and storage – are expected to serve approximately 85 percent of microgrid customers’ annual electricity consumption.

During a planned or unplanned outage, the proposed microgrid will perform safe islanding and maintain stable operation through the transition from grid-connected to island mode. Microgrid generation, energy storage, and demand response capabilities are sized to support stable transition to island mode during peak seasonal and time-of-day peak load cycles, and to support island operation for a minimum of seven days, with multi-week operation possible. The microgrid will dispatch storage, generation, and demand-response resources to support resilient energy service for microgrid customer loads throughout the duration of an outage. Based on the nature of the outage and the utility’s estimated restoration time, the microgrid control system will dispatch resources to maintain service essentially indefinitely at 80 percent of normal demand levels.

A. *Electricity supply:* Proposed local generation resources are expected to serve approximately 85 percent of microgrid customers’ annual electricity purchases. Remaining microgrid energy requirements will be met by offsite energy supplies, via Orange & Rockland retail delivery to the microgrid PCC.

B. *Electricity storage:* Battery energy storage systems (ESS) are specified to support seamless transitioning from one operating mode to another (islanding and re-connection), with load-following and economic dispatch performed to support optimal resiliency, renewable integration, emissions reduction, and financial performance.

C. *Thermal energy supply:* Onsite combined heat and power systems will augment or in some cases replace existing thermal heating and cooling systems. CHP units are sized to meet baseload energy requirements, with some capacity for load following, in coordination with building controls, peaking generation, storage, and load-management resources.

D. *Thermal energy storage*: Thermal storage is modeled to assume potential improvements in onsite hot water systems that may increase effective thermal storage. Additionally ice storage for off-peak pre-cooling may reduce building cooling costs during summertime and provide load-management capacity to support resilience.

E. *Load-management systems*: Demand-side management tools including automation to support peak-load shifting, dynamic demand response, resource scheduling, and system balancing.

### 3.1.8 Planned contractual agreements

(See also 3.1.1 Commercial Terms and Relationships)

Primary contractual agreements involve energy services agreements (ESA) and a build-operate-transfer (BOT) agreement. Microgrid infrastructure and systems will be installed pursuant to contracts the P3 enters with vendors and service providers. Other forms of agreements, covenants, and policies may support financing resilience assets such as solar gardens, neighborhood energy storage, and other infrastructure. Finally, the microgrid P3 will be incorporated as the result of partnership agreements among public and private owners.

**Table III-C: Counterparty agreements – Energy transactions**

Counterparty A	Counterparty B	Agreement Type	Term	Notes
<b>Warwick Microgrid P3</b>	Microgrid customers	ESA	25 years	terms TBD
	Orange & Rockland Utilities	BOT	6-25 years	wires assets and obligations to be transferred to utility; BOT terms TBD
<b>Third-Party Suppliers</b>	Warwick Microgrid P3	ESAs, spot contracts	varies	terms TBD

### 3.1.9 Customer recruitment and onboarding

The proposed project is well suited to serving the strategic energy and resilience goals of the Warwick community, and provides an attractive value proposition for customers. Ongoing engagement processes have served to maintain and strengthen project commitment by key stakeholders that account for more than half of the microgrid’s energy loads. For most other prospective customers, the proposed microgrid offers obvious customer resilience benefit and economic value. Accordingly the team estimates that with few exceptions, prospects are strong for recruiting substantially all customers included in the Task 2 model.

The Warwick Microgrid P3 will be responsible for marketing and promoting service offerings at all phases of implementation:

- Phase I: Completion of onboarding efforts for customers who operate facilities identified as critical and vital. The NY Prize Stage 1 study process effectively initiated Phase I onboarding for microgrid customers, via the project team’s stakeholder outreach, education, and collaborative planning efforts.
- Phase II: Continued outreach and engagement with all microgrid customers during microgrid deployment and P3 enterprise development.
- Phase III: Outreach and engagement with additional customers to expand and extend community benefits through future development.

### 3.1.10 Describe other commodities provided

The microgrid will offer energy commodities in addition to electricity, specifically at sites where combined heat and power (CHP) units are required to support resilience. Additionally, the community's strategic goals include reducing reliance on fossil energy and increasing use of local renewable resources. Accordingly, the proposed P3 could expand the commodities it provides in the future.

*A. Heating, cooling, and domestic hot water:* CHP systems in the microgrid will provide thermal energy, primarily hot water, to customers where the systems are located. Cooling may be provided via absorption chilling at some microgrid nodes. Future opportunities for P3 development include integrated community heat planning and district energy implementation – with solar thermal, geothermal, and CHP resources – effectively expanding the community's baseload generation resources and saving additional costs and emissions.

*B. Biomass fuel:* The project team determined that available local biomass resources are insufficient to support cost-effective deployment to meet the microgrid's objectives. Nevertheless, the community remains supportive of biomass development and would contemplate participating in biomass energy initiatives as they become available. Potential examples include participation in regional anaerobic digestion or biomass pelletizing projects. Accordingly, the proposed P3 could become a producer of biomass or biogas fuels.

### 3.2 Commercial Viability - Value Proposition

*(See also 3.1 above.)*

The Warwick Microgrid value proposition is based on three key principles: 1) It will produce net economic benefits to customers and the community in excess of its life-cycle costs; 2) It will increase the community's energy resiliency, especially at critical facilities; and 3) It will serve the community's strategic goals, most notably modernizing infrastructure and providing a platform for ongoing reductions in fossil fuel consumption.

The technical team performed an iterative modeling process to arrive at a resource mix that produces a positive economic return to the microgrid P3 with an optimized mix of electric and thermal energy system upgrades. The proposed investments in resilient energy systems also would support a range of other community benefits.

#### **A. Life-cycle economic benefits:**

- a. **Customer Cost Savings:** The team's Task 2 analysis indicated that the Warwick Microgrid is financially viable, even while providing services to microgrid customers at costs equal to or less than current costs.
- b. **Positive Revenue/Cost Outlook:** The team's analysis indicated that projected revenues would exceed estimated costs by enough to support a positive internal financial return (at least 7.6%).



**B. Improved community resiliency**

- a. The project envisions infrastructure modernization investments, selectively aimed at ensuring maximum community resilience outcomes. This infrastructure improvement will benefit a broad range of stakeholders in the Warwick area. Examples:
  - i. Vulnerable populations will be better prepared to shelter in place in emergency situations that often accompany extended outages
  - ii. Residents will have continuous access to municipal water and sewer service
  - iii. Area residents will have continued access to hospital care and other key services

**C. Community strategic goals**

The Warwick Microgrid business model is designed to support four strategic goals (*see Table III-D*).

**Table III-D: Community goals and microgrid P3 strategy**

Goal	Objectives	Strategy	Implementation
<b>Improve community resiliency</b>	Improve the resiliency of services that are critical to the health, safety, and vitality of the community	Install resilient energy microgrid infrastructure, control system, and DERs to serve critical facilities	- Multi-node microgrid - Future expansions of microgrid services
<b>Expand local renewable energy production</b>	Increase community’s use of local renewable energy assets, and enable local renewable energy investment	Establish and market energy services to increase local renewable energy development and investment	- Resilient onsite and shared solar and storage assets - Regional biomass energy production
<b>Reduce fossil dependence and environmental footprint</b>	Reduce the community’s fossil energy consumption and related emissions	Establish and market energy services to increase local renewable energy production and energy efficiency	- Renewable energy deployments - Energy conservation upgrades and expansions
<b>Cultivate economic growth</b>	Update and position local infrastructure for business development and expansion	Modernize and improve power system, supporting community service capacity, new business development, and potential new jobs	- Advanced microgrid infrastructure - Multi-node, extensible microgrid control system - Integrated community planning

**3.2.1 Community costs and benefits**

A. *Community benefits summary:* The proposed microgrid produces a wide range of benefits, as described throughout the Task 2 and Task 3 reports. They are summarized as: 1) Improved resilience for critical facilities; 2) opportunities to expand local investment in renewable energy and conservation; and 3) support for economic growth and development. Additionally the team’s analysis indicates the proposed microgrid can produce direct economic benefits, providing enhanced services to customers for costs that are equal to or lower than current costs.

B. *Capital requirements:* The proposed microgrid can cost-effectively provide energy for microgrid customers through 25-year ESAs at costs equal to or lower than current electricity rates. The proposed business model would support commercial financing for a substantial portion of the project’s estimated

\$6 million initial capital cost. Capital contributions – in the forms of equity investments, in-kind assets, or concessions – will reduce the financed portion of project capital requirements and accelerate simple payback.

C. *Cash-flow viability*: Operating revenues for the modeled microgrid are projected to exceed operating costs – sufficiently to produce a 7.6% internal rate of return to the P3. Positive cash flow will ensure economic stability and creditworthiness to support continued access to low-cost operating and investment capital.

D. *TE study notes*: Implementation of a TE pilot project would provide an opportunity to demonstrate micro-market mechanisms to produce true geotemporal values for DERs. In other words, a TE approach would be expected to more faithfully reflect the true costs and benefits of energy service for a given party at a given time. Collectively, loads served by a TE microgrid would produce incremental community benefits by reducing energy consumption and shifting energy spending toward local resources. A TE micro-market would be based on a combination of long-term contracting and spot-market transactions, enabling customers to obtain the degree of resilience they need at the most competitive price. Consequently, the community’s overall costs and benefits’ would depend in large part on customers’ energy consumption and investment choices, resulting in market-based outcomes that serve customers’ priority needs.

### 3.2.2 Utility benefits

(See 3.1.3 above)

As discussed in section 3.1.3, the proposed microgrid will provide numerous utility system benefits, including congestion relief, outage response support, distribution system modernization, reduced line losses, enhanced community microgrid service options, and ancillary services benefits.

### 3.2.3 Proposed business model

The microgrid P3 will operate using an energy services company (ESCO) business model, providing a range of energy services under long-term and short-term agreements with customers.

The project team anticipates resolving operational details about terms of contracts and transactional approaches in Stage 2 study and development.

### 3.2.4 SWOT analysis

#### A. Strengths

- a. Diverse and committed stakeholder group: Key stakeholders have demonstrated ongoing and substantive engagement in project planning and execution processes
- b. Demonstrated need for resilience improvements: Identified critical community assets lacking resilience to extended energy disruptions
- c. Positive benefit-cost analysis: Iterative modeling yielded financially viable configuration
- d. Strong community support: Demonstrated community interest in energy resource and efficiency improvements

- e. NY REV and modernization support: Opportunities to foster innovation and competitiveness, and deliver life-cycle benefits through customer-centered P3 business structure and operational model

**B. Weaknesses**

- a. Geographic dispersion: Economics challenged by multiple small nodes and load profiles
- b. Complex business structure: P3 complexity impairs access to some forms of commercial financing
- c. Stakeholder capital limitations: Capital investment priorities focused on core activities
- d. Industry acceptance: P3 and BOT structures unconventional for U.S. utility assets (although common in other energy and infrastructure areas, in the U.S. and abroad)
- e. Administrative load: Any P3 business entity requires sustained management support by sponsors, requiring allocation of adequate staff resources.

**C. Opportunities**

- a. Modernize resilient energy systems: Improve resilience of several facilities critical to the health, safety, and vitality of the Warwick community, by modernizing and upgrading critical energy infrastructure
- b. Integrated community planning: Support integrated community development and economic planning among local government entities and stakeholders
- c. Diverse capital stack: Leverage P3 structuring, financing benefits, and risk management
- d. Support local self-reliance: Reduce dependence on imported energy supplies

**D. Threats**

- a. Onboarding risks: Final business and contractual structures must address all key customers’ needs and concerns and improve risk allocation and management
- b. Utility business or legal challenges: Collaborative planning required to engage utility, resolve conflicts, and align goals and opportunities with policy and program support from New York State agencies
- c. Market alternatives: Competitive energy suppliers offering ESA and net-metering arrangements as part of retail energy marketing
- d. Integrated planning challenges: Need to maintain ongoing, consistent commitment to microgrid objectives by government units, community stakeholders, and the utility

**3.2.5 Unique features of the site or technologies**

*A. Innovative technology architecture:* The proposed project envisions an innovative approach at the systems level that utilizes commercial, off-the-shelf technologies to create a community microgrid that serves multiple critical facilities and community partners at non-contiguous locations. Members of the project team have proven the distributed microgrid model in several successful prior projects. The approach involves three steps:

- 1) Organize clusters of nearby critical facilities into microgrid nodes, and optimize reliability and resiliency within each;
- 2) Coordinate all microgrid nodes to optimize financial performance and emissions reduction across the entire community; and
- 3) Size the total energy resource portfolio to support some non-critical loads. In this approach, if there is a grid loss within the community, service to non-critical loads may be interrupted to support critical facility loads.

In Warwick, this means serving a very diverse set of loads – from water and wastewater treatment systems, to a multi-facility healthcare complex, to a gas station and a pharmacy. The Warwick Microgrid design will provide true energy resilience for the community – not just emergency services.

*B. Former prison site/economic development zone:* The site of the former Mid-Orange Correctional Facility (MOCF) area represents an ongoing multi-phase economic redevelopment district, with new roadways and utilities being installed, and plans for new underground electric service. In addition to Town of Warwick water and wastewater facilities that are included in microgrid nodes, the area is a designated office and technology park with plans for a variety of industrial, commercial, and housing facilities. Current plans are too nascent for analysis, so the site was omitted in this phase of study except to note the opportunity for integrated community planning to support economic growth and redevelopment, as part of subsequent microgrid expansion.

### 3.2.6 Project replicability and scalability

The Warwick Microgrid Project establishes a highly replicable and scalable approach to providing resilient energy and other energy services for New York communities.

*A. Structures:* Ownership and management structures developed for the Warwick Microgrid can be used in other community microgrid situations. Additionally these structures are highly adaptive and scalable, being viable and supportive for projects of various sizes and strategic purposes.

*B. P3 ESCO model:* The Warwick Microgrid’s P3 ESCO model establishes an approach that is readily adaptable for application in any community that can benefit from integrated sustainable-planning and economic development.

*C. Design and technology approach:* By specifying resilient infrastructure and resources in standard configurations, and by providing controls for managing clusters and portfolios of facilities that serve community resilience, the Warwick Microgrid’s design and technology approach establishes a roadmap for community resilience in New York and jurisdictions with analogous market and regulatory conditions.

*D. Financing:* By structuring community microgrid agreements and covenants to support commercial financing, the project will help establish programmatic financing models for adaptation in other communities with similar needs and wants.

*E. Phased development strategy:* The project team’s integrated planning and multi-phase development approach demonstrates methodologies for communities to meet immediate needs while planning and preparing for future growth and development.

### 3.2.7 Community need for resiliency

The benefits of the Warwick Microgrid extend not only to local agencies and businesses, but also to residents in the greater Warwick area. The Warwick Microgrid will serve a group of facilities that are critical to community health, safety, and vitality. This mix includes government facilities (Village, Town), public safety and infrastructure, private healthcare and assisted living, and private business interests. In addition to critical facilities, the microgrid footprint includes other essential services, including pharmacies, banks, and gas stations.

In addition to operational resilience, the microgrid system will contribute to the economic resilience of the community. By facilitating the deployment of resilient DERs and providing service to customers under long-term agreements, the microgrid will help Warwick customers to hedge against anticipated

energy cost increases and volatility. Additionally the proposed microgrid will create a modernized energy infrastructure to attract new businesses and jobs to the community.

### 3.2.8 Overall project value proposition

(See also sections 3.1 and 3.2)

The Warwick Microgrid overall value proposition is based on three key principles:

- A. *Positive business case:* The proposed microgrid will produce net economic benefits to customers and the community in excess of its life-cycle costs. The project team estimates that the proposed microgrid will save the community approximately \$95,000 per year in energy costs, in current dollars;
- B. *Improve community resiliency:* The microgrid will increase the community’s energy resiliency, to support both emergency services and vital commercial activity. The proposed microgrid will provide resilient energy services to numerous critical facilities in Warwick; and
- C. *Enhance local energy economy:* The microgrid will serve several strategic goals, most notably providing a platform for ongoing reductions in fossil fuel consumption. The proposed microgrid’s integrated planning approach and P3 energy services structure support many strategic goals including enhancing local energy infrastructure and economics.

### 3.2.9 Added revenue streams for the off taker

- A. *Prosumer opportunities:* As a partnership that includes local public entities among its ownership group, the proposed microgrid would generate new energy services revenue for P3 owners who also are energy customers in Warwick. Examples:
  - a. *Onsite green energy production:* The microgrid P3 could accommodate multiple customer options for onsite energy systems, including for example rooftop PV systems that would generate revenue by selling electric output in excess of offset electricity consumption;
  - b. *Thermal energy services:* Some microgrid P3 customers may have the opportunity to sell thermal energy output from onsite CHP facilities to onsite or nearby thermal customers; and
  - c. *Shared solar production:* The microgrid P3 may offer customers opportunities to participate in community solar gardens or other shared energy resources that are sited, designed, and developed to support critical facility resiliency. Shareowners or subscribers in such facilities would generate revenue by selling electric output in excess of their offset electricity consumption, and potentially by re-marketing their asset shares after subscription limits are reached.
- B. *TE study notes:* The purpose of implementing a TE micro-market includes establishing opportunities for prosumer investments and market competition. A prospective TE implementation could allow further study of opportunities for customers to engage fully in DER micro-markets, from acquiring shared solar assets to developing neighborhood storage systems. Such opportunities could allow energy customers to earn revenue by selling energy and capacity to other counterparties in TE micro-markets.

### 3.2.10 State policy implementation

The Warwick Microgrid directly promotes several New York State policy goals.

*A. Reforming the Energy Vision (REV):* The Warwick Microgrid serves several major goals of the REV process, including providing project development and analysis to guide regulatory change, inform development of DSP functionality, measure and monetize customer participation, and guide effective DER implementation. Notably, the project team proposes an innovative P3 energy services model, which establish new approaches for communities to facilitate local investments to serve communities' defined needs. The proposed microgrid establishes a framework for communities to perform integrated planning necessary for DER investments to achieve resiliency improvements and related energy and economic goals. The project also establishes innovative mechanisms for partnering with utilities to obtain their technical support for community microgrids, while also informing the advancement of DSP functions and practices.

*B. Renewable energy goals including RPS:* As designed the proposed microgrid would incorporate substantial new renewable energy and storage capacity to serve microgrid customers. As a result the Warwick community will increase reliance on renewable resources. Moreover, such resources will be sited, built, and optimized to serve local resiliency needs, thereby producing greater value to the community and the state than non-resilient renewable assets.

*C. CHP, conservation, and demand-side management:* The proposed microgrid will demonstrate the use of modular CHP systems and load-management systems and methodologies to achieve a range of objectives, including resiliency and economic and environmental benefits.

*Discussion:* The project serves New York grid modernization objectives, including increasing community resiliency and reducing the effects of outages and lost economic productivity. The project also will optimize demand including reducing system and customer costs by better managing peak demand, load factors (of the system and by customer class), and reductions in system line losses. The project will also offer a better integration of distributed resources, and opportunities to improve workforce and asset management for the benefit of customers and the community served.

The microgrid provides a set of important tools enabling community control and benefits. Microgrid projects offer the opportunity for integration of resilient energy supply, renewable energy, efficiency and load-management capabilities, and ESS technology at the neighborhood and facility level. Information technology and operating environments will become flatter with more interactions with the customer and increasing opportunity to engage in real-time operations. This is centered in a market and regulatory environment in which a wider array of viable energy substitutes is appearing. The proposed microgrid enables the community to exploit these market changes and technology advances to serve a variety of local objectives.

Successful communities will assume the role of energy integrators, including the business and technical responsibilities for providing all sources of energy supply safely and reliably to customers. This encompasses both demand and supply strategies, and it requires information technology (IT) and operations technology (OT) infrastructure that is more sophisticated and robust than existing grid systems. While per-capita energy usage may increase with increased electrification, the proposed microgrid offers the community a platform for integrating multiple solutions to enhance resiliency and reduce energy consumption.

The New York REV process recognizes that with these changes, the business and technical structures for delivering energy services must adapt to accommodate innovation, competition, and increased customer optionality. Accordingly utilities are expected to expand and develop their platform services to enable and manage these changes and produce customer outcomes based on real-time locational value and data analytics rather than formulaic rate-regulated cost recovery. Moreover, historical utility business models will change as customer service requirements and cash-flow sources change. In that context, the proposed microgrid will demonstrate new revenue-generating platform service opportunities for utilities, established on the foundation of state goals to ensure the delivery of safe, reliable, and affordable energy services.

The proposed project serves State objectives to develop better and best practices to foster more optimal business outcomes for local community leaders, in support of their public service and economic development goals. NY Prize projects and the New York REV process create opportunities to develop such optimal outcomes using new business models and approaches to providing service, rather than relying solely on legacy rate-based utility business structures and practices, which are becoming less effective in a 21<sup>st</sup> Century market.

Finally, the proposed project supports integrated community planning efforts, demonstrating methodologies enabling communities to capture greater benefits and cost efficiencies. This serves State goals to enhance community resiliency and opportunities for sustainable economic development.

### 3.2.11 Commercializing advanced technologies

(See also 3.2.5)

A. *Microgrid platform:* The Warwick Microgrid establishes a technology and business platform for deployment and operation of multiple technologies to exploit DER. The platform itself represents innovative technology – specifically, the microgrid controller and optimization software required to perform active energy management and system balancing among various DER systems.

The microgrid platform will enable autonomous functionality of the microgrid and minimize the need for on-site operators. The controller will operate the microgrid to maximize economic benefits, minimize emissions, and maximize reliability of service. In addition, the microgrid controller will monitor the performance, operation, and alarms of distributed resources. In the event of an alarm, the microgrid operator will be notified through the network operations center, and dispatch a service technician engaged through a service contract. The microgrid controller also will track the hours of operation of each microgrid resource, and will employ a predictive maintenance strategy to schedule maintenance before any failure occurs, and at a time that will have the least impact on the overall operation of the microgrid. As the microgrid operates, it will generate a history of performance, trending and signature analyses, which will enhance the microgrid’s ability to anticipate failures.

B. *Utility integration:* The microgrid controller will provide a means for the utility to integrate the microgrid into its distribution management system, giving the utility insight into the microgrid status and operations and the ability to manage island-mode operations to ensure the safety of line workers and community members.

C. *Resilient DER deployments:* DERs are most valuable when they are designed, installed, and operated to produce a full range of customer benefits – including resilience. The Warwick Microgrid will directly promote adoption and development of advanced DERs by optimizing their use to support community resilience while also producing environmental and economic value.

The Warwick Microgrid project will seek to leverage turnkey CHP systems, as identified by the NYSERDA CHP Acceleration Program. The complete set of the community’s reliability, financial, and emissions objectives will drive the type of CHP units selected and their mode of operation. ESS units will be distributed along with CHP and PV to provide voltage and frequency support, smoothing and time-of-day shifting of solar PV output, island mode transition support, VAr management, and black start capabilities.

D. *TE micro-market demonstration:* In principle, the proposed Warwick Microgrid could serve as a platform for a pilot or demonstration project to implement TE micro-markets. Such a project could allow further study of prosumer participation and distributed controls for real-time micro-market dispatch of DERs, to achieve maximum economic and environmental objectives for the community. Additionally it could provide the opportunity to develop, demonstrate, and refine approaches that continuously exploit DER units’ specific real-time locational (*e.g.*, geotemporal) value. However, community stakeholders do not support such expansion of the project objectives at this time, and so a TE micro-market demonstration is not anticipated for the Warwick Microgrid in initial deployment phases.

### 3.3 Project team

The project team is well positioned to continue project efforts in subsequent phases. The team has collaborated to execute the NY Prize Stage 1 feasibility analysis, effectively managing and executing a variety of project tasks with expert resources drawn from existing staff. Team members are committed to the project and anticipate continued engagement with Warwick stakeholders to further develop and refine engineering design, business model, and financing structures.

#### 3.3.1 Community engagement and support

Ongoing engagement has ensured continued support and involvement by a variety of Warwick stakeholders. The community of Warwick generally has a high degree of support for renewable energy and environmental initiatives, and the Warwick Microgrid has leveraged this support by establishing an ownership structure and energy services model that directly serves community interests.

A. *Integrated planning and collaboration:* The project team anticipates continued collaboration with community stakeholders in Stage 2 and subsequent project phases. Key community stakeholders – most notably leaders at the Town and Village of Warwick and the Bon Secours Charity Health System – have maintained productive cooperation with the project technical team, supporting a robust integrated planning approach. Stakeholder representatives have contributed direct assistance by providing information about energy usage and strategic plans, facilitating outreach and engagement with other community members, and participating in project update calls and briefings.

B. *Public outreach:* The technical team anticipates continued outreach and education efforts to build upon Stage 1 progress. The team has developed and distributed project background materials to support ongoing outreach and engagement. The technical team has either physically visited or conducted phone outreach with most proposed microgrid customers.

#### 3.3.2 Team member roles

Team members in the Stage 1 feasibility assessment expect to continue supporting the project in subsequent development phases. Additionally, the project team anticipates expanding its capabilities in subsequent project phases to meet expanded project role requirements. Such roles may include, for example, project financial structuring and risk management, full-scope engineering-procurement-construction, and operations, maintenance, and administration.



**Table III-E: Team member roles**

Team Member	Roles	Relationship
<b>Microgrid Institute</b>	Principal investigator, project manager - <i>Microgrid design, development, outreach, economic and legal structuring and analysis, and financing</i>	Prime contractor
<b>Hitachi Consulting</b>	Technical partner - <i>Microgrid design, modeling, and technology and resource assessment for development, financing, and deployment</i>	Subcontractor
<b>Green Energy Corp.</b>	Technical partner - <i>Microgrid control system analysis</i>	Subcontractor
<b>TeMix Inc.</b>	Technical consultant - <i>Transactive energy micro-market analysis</i>	Subcontractor

**3.3.3 Public-private partnerships**

The project team anticipates that the proposed Warwick Microgrid will be owned and operated by a public-private partnership (P3), combining private business and public organizational models to enable integrated planning, ensure strategic focus on community objectives, and provide access to a full range of funding and financing options. The P3 approach provides a comprehensive but flexible structure enabling the community to leverage investments that best support resiliency for critical services, while improving the community’s energy and environmental infrastructure and supporting ongoing economic development. The team anticipates the P3 ownership structure will be formalized in Stage 2.

**Fig. III-A Public-private partnership structure**

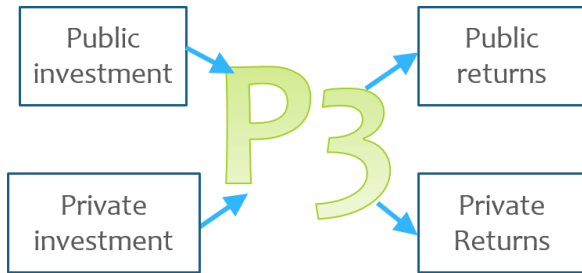

**Table III-F: P3 equity partners**

Category	Prospective Owners
<b>Public</b>	Town of Warwick, Village of Warwick, Warwick Fire District, Warwick Ambulance Corps
<b>Prosumer</b>	Bon Secours Charity Health System and individual businesses, institutions, and residential co-owners of microgrid resources
<b>Private</b>	Microgrid Institute, Hitachi, Orange & Rockland Utilities, third-party investors

**Fig. III-B: Microgrid P3 operating structure**

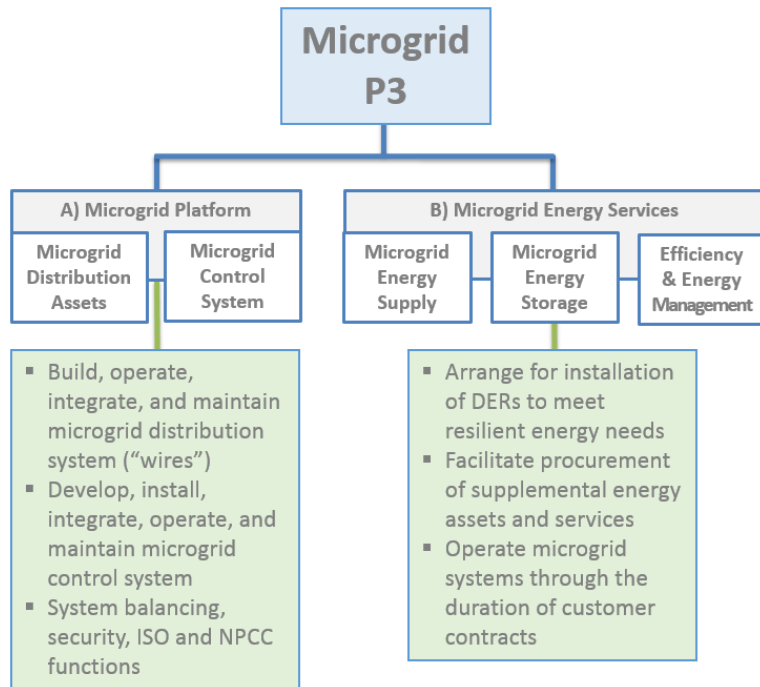

**3.3.4 Utility engagement and support**

The project team is discussing with Orange & Rockland what commitment is required for Stage 2 progress. Orange & Rockland provided a letter of support for the Warwick Microgrid NY Prize Stage 1 application, and supports assessment efforts with utility system information, guidance, and engineering analysis. The team anticipates continued engagement with the utility as the project proceeds.

**3.3.5 Financial strength of the applicant**

The applicant for the Stage I feasibility analysis (Burr Energy LLC *dba* Microgrid Institute; DUNS 051595854) is a small business established in 2013. The company’s primary revenue sources are derived from contracts with government entities (U.S. Department of Energy, the State of Minnesota, and the State of New York). The applicant’s accounts with clients, subcontractors, and vendors all are in good standing. Project team members have engaged in multiple contracts with the applicant, and their continued involvement assures continued resource capacity and stability for the project.

The applicant will work in close collaboration with other team members, affiliates, government entities, and third-party participants to facilitate efforts in subsequent project phases.

**3.3.6 Team qualifications**

The proposed Warwick Microgrid project team is comprised of a collaborative group of companies with substantial expertise in microgrid technology, development, engineering, and deployment.

- *Microgrid Institute*: A collaborative organization that leads multidisciplinary projects focusing on microgrid development, Microgrid Institute serves as prime contractor and principal investigator for the Warwick Microgrid project. In addition to expertise in community microgrid planning,

design, research, development, and financing, Microgrid Institute brings demonstrated stakeholder engagement and facilitation capabilities, and experience managing government project contracts and subcontracts. The organization leads the Olney Town Center Microgrid project, a U.S. DOE project to develop and test control systems for multi-node community microgrids in Maryland.

- *Hitachi America Ltd. / Hitachi Consulting Corp.:* A U.S. corporation with project staff offices in New York, Hitachi is a major infrastructure and consumer services company with substantial experience designing and implementing community resiliency and smart city projects. In addition to market-leading expertise in advanced energy efficiency and conservation, Hitachi brings microgrid design, engineering, and financing capabilities to the project team.
- *Green Energy Corp.:* GEC is a small business and a C-corporation incorporated in Colorado. GEC brings substantial experience designing and developing microgrids for a variety of purposes, as well as the open-source GreenBus DER control platform and market-leading expertise in multi-node community microgrids. The GEC team worked with multiple stakeholders to build the first operating community microgrid in the United States, in Borrego Springs, Calif. The company is leading R&D and design efforts for the Olney Town Center Microgrid, a project to develop and test control systems for multi-node community microgrids in Maryland.
- *TeMIX Inc./Ed Cazalet:* TeMIX Inc. is a provider of transactive systems and services to the power and energy industry. CEO Ed Cazalet is an acknowledged expert on transactive energy micro-markets, with extensive experience with high-speed, reliable transaction systems for electric power. Cazalet founded Automated Power Exchange (APX, now part of NYSE Euronext), and served as interim CEO and vice chairman of the California Independent System Operator (CAISO) board of governors. He contributes to several industry standards initiatives including NIST Priority Action Projects and OASIS technical committees and working groups.

The project team anticipates expanding its capabilities in subsequent project phases to meet expanded project scope requirements. Such capabilities may include, for example, partners or consultants with commensurate project financial structuring and risk management, full-scope engineering-procurement-construction, operations, maintenance, and administration expertise.

### 3.3.7 Contractors and suppliers

The model for the proposed microgrid is based on standard equipment specifications for multiple types and sizes of photovoltaic systems, lithium-ion battery energy storage systems, combined heat and power units, and PCC components. The project team anticipates engaging a variety of contractors and suppliers to implement and operate the proposed microgrid. The microgrid P3 will seek to serve as a procurement agent for its owners and customers. Accordingly the project team anticipates maintaining optionality in contracting and procurement until the appropriate phases of implementation, and at that time, the microgrid P3 will execute a combination of competitive procurement and best-of-breed selection to ensure technology and materials are selected to meet all project objectives, including optimal financial economics and technical performance.

### 3.3.8 Project capital sources

The project team anticipates a financial structure with a capital stack containing elements of more than one form of financing. Prospective capital sources have been identified for some portions of the capital stack, but the team has not initiated financial structuring activities in the current preliminary phase of assessment. Stage 2 progress is expected to include further development of cash-flow and return expectations, and access to capital necessary to fund the project's long-term (25 year) value proposition.

**Table III-G: Project capital sources**

<b>Capital component</b>	<b>Identified capital sources</b>	<b>Other potential sources</b>
<b>Equity (cash and capital assets)</b>	Town of Warwick Village of Warwick	Private prosumers (consumer/producers) Vendor financing (construction) Commercial equity investors
<b>Grants</b>	NYSERDA (including NY Prize)	NYPA, U.S. DOE, HUD
<b>Construction financing</b>	NY Green Bank	Vendors, EPC firms, commercial banks
<b>Long-term debt financing</b>	NY Green Bank, Energy Finance Solutions (on-bill recovery financing)	Institutional investors, commercial finance consortia
<b>Tax-based financing (TIF, PACE, municipal bonds)</b>	Energize NY	Municipal bond investors

### 3.3.9 Legal and regulatory advisors

Microgrid Institute Washington Counsel Michael Zimmer serves as the team’s legal and regulatory advisor. Mr. Zimmer previously served as senior counsel with Thompson Hine LLP, practicing in the law firm’s Energy Unit in the Corporate Transactions Group in Washington, D.C. He has been involved since 1985 in industry transactions exceeding \$15 billion in value, including project development, financing, construction, mergers and acquisitions in the non-utility generation, renewables, natural gas and electric, rural cooperatives, clean tech energy, emissions trading, and manufacturing sectors. He served as national co-chair of the American Bar Association Renewables and Distributed Energy Committee and the ABA’s Energy & Environmental Markets and Finance Committees from 2008-2012. He serves as a fellow and executive in residence at the Voinovich School of Leadership & Public Affairs and the Russ School of Engineering at Ohio University. Mr. Zimmer is admitted to practice in the District of Columbia.

### 3.4 Creating and Delivering Value

*(See 3.1, 3.1.1, 3.2, and 3.2.8)*

The proposed project will create and deliver value for the community using a P3 energy service company model. The microgrid P3 will serve as the Warwick community’s ESCO, arranging for full-scope energy supply, storage, efficiency, and load management necessary to provide resilient energy services throughout the term of customer contracts.

#### 3.4.1 DER technology selection and challenges

As the DER portfolio is structured, the project team will determine the size, manner of use, and specifications of each piece of DER equipment, and identify vendors to provide the equipment. The project team made some of these decisions (resource type, sizing, operation, and location) as part of the NY Prize Stage 1 feasibility assessment, and reported these decisions in the Task 2 report. Other decisions (such as specifications and vendors) will be made in the detailed design phase of the project (Stage 2).

The project team will give preference to the most mature technologies available for each purpose that meet or exceed the stakeholder and design objectives. Where the project must use emerging technology (namely microgrid controls and energy storage) the project team will take special measures

to prove each product before including it in the microgrid. These measures will include detailed and thorough testing and commissioning, and securing strong vendor warranties that include obligations to quickly resolve any issues that may arise.

The project team used the following criteria to make design and technology selection decisions.

#### **A. Combined Heat and Power units**

*Selection Factors:* The project design specifies the following criteria to support CHP procurement:

- High overall performance
- High availability (hours per year)
- Low \$/MWh
- Low emissions/MWh
- Proven continuous duty
- Low capital cost (\$/kW installed)
- Low O&M cost (\$/kWh)
- Readily available troubleshooting and maintenance service
- Manufacturer reputation
- Warranty provisions

*Benefits:* Fulfills the need for base generation in the microgrid resource portfolio approach. CHP applications provide high overall efficiencies.

*Challenges:* Typically fueled with fossil energy, fuel costs, maintenance and overhaul costs.

*Design Considerations:*

- Fuel Supply
- Available Space
- Siting
- Sound levels
- Heat Recovery Opportunities
- Load Following Operations
- Maintenance Requirements

*Current Resources to be Leveraged:* None

#### **B. Photovoltaics**

*Selection Factors:* The project design specifies the following criteria to support PV procurement:

- Hail rated
- Low annual degradation < 0.5%/yr
- High watts per panel
- Capital cost (\$/kW installed)
- Low maintenance
- Manufacturer production capacity
- Manufacturer history
- Manufacturer reputation
- Warranty provisions

*Benefit:* Generation profile generally aligns well with the load profile, which is energy efficient; very low O&M, zero fuel cost.

*Challenges:* Low overall capacity factor and intermittency due to clouds. Installation locations can be challenging due to structural integrity of roofs, shading and space.

*Design Considerations:*

- Available Space
- Installation Locations
- Shading Issues
- Intermittency
- Orientation and tilt
- Maintenance Requirements
- Resiliency to wind and snow

*Current Resources to be Leveraged:* Warwick currently has two PV installations that will be leveraged by the proposed microgrid – a 60 kW system at the Mt. Alverno Center and a 24 kW system at the Warwick Town Hall and Police Station. The P3 will incorporate these systems into the microgrid so they can continue to generate energy for their host facilities when the system is operating in island mode.

### **C. Energy storage systems (ESS)**

*Selection Factors:* The project design specifies the following criteria to support ESS procurement:

- Compatible sizes and performance to our needs
- Low annual degradation
- Ramp rates
- Charge and discharge rates
- High AC – AC round trip efficiency
- Rated number of cycles
- Total capacity requirements (kWh per cycle)
- History in the field beyond the laboratory
- PCS and battery management system integration
- Available modes of operation
- Manufacturer reputation
- Warranty provisions

*Benefits:* Provides many functions in one efficiently operating unit (PV smoothing, peak shifting, VAR management, frequency support, voltage support, black start, mode transition management, etc)

*Challenges:* High installed capital cost, risk of shortened life from mismanagement.

*Design Considerations:*

- Selection
  - Technology
  - Battery System
  - Power Conversion System (PCS)
  - Integration
- Sizing
- Siting
- Modes of Operation
- Control Optimization

*Current Resources to be Leveraged:* None

#### **D. Microgrid Controls**

*Selection Factors:* The project design specifies the following criteria to support procurement of microgrid controls:

- Multi-objective optimization
- Real-time operational background
- Ability to actively communicate with devices and resources in real-time
- Manufacturer reputation / likelihood of being around for more than 5 years

*Benefits:* Active microgrid controls provide economic optimization, reliability optimization, resiliency optimization, and emissions optimization, provides a data rich environment for trending, signature analysis, and sharing with stakeholders.

*Challenges:* Immature technology with few quality vendors holding solid track records. Many traditional vendors are offering programmed logic controls, which cannot provide the optimization functions expected of microgrid controls.

*Design Considerations:*

- Platform
- Vendor Experience
- Architecture
- Control Approach
- Optimization
- Communications
- Cyber Security
- Integration experience with selected DER
- Overall system experience with integration, startup, and commissioning
- Cost structure

*Current Resources to be Leveraged:* None

#### **E. PCC and underground cabling**

The utility will need to analyze and approve the final engineered design for system interconnection, switching, and protection systems that provide disconnect, islanding, and restoration functions in case of power disruption. The utility will also need to approve any plans to use of sections of utility distribution equipment while in island mode.

The utility will coordinate protection and switching schemes for the PCC and the distribution system. The microgrid P3 will address these needs in the interconnection agreement and the studies that support it. The proposed PCC solution simplifies the interconnection agreement and interconnection study by using a straightforward approach to isolate the microgrid from the distribution grid with control by the utility in accordance with the IEEE 1547 interconnection standard. This gives the utility control of the interconnected system and makes the interconnection agreement easier to execute.

The project team anticipates the proposed project will require investment in new distribution equipment, including PCCs at all nodes, 4.8 kV, 3-phase underground line segments in some nodes, and hot water supply connections for CHP systems. The project will leverage existing automatic transfer switches to leverage emergency backup power when needed.

The proposed microgrid will use underground cable segments to connect loads in multi-facility nodes (e.g., Nodes 1 and 7). Overhead distribution lines do not provide the resiliency or reliability required to meet project objectives, and so the microgrid design is optimized to minimize reliance on vulnerable above-ground systems. Ownership of new purchased and installed underground cabling may be retained by the P3 or transferred to the utility pursuant to a BOT agreement, based on the objectives of community stakeholders. The REV proceedings include a consideration of such arrangements.

The team anticipates that in subsequent expansion phases, the proposed project would utilize underground cable planned for installation at the former Mid-Orange Correctional Facility site. To the degree the proposed microgrid uses utility-owned underground cable and other distribution equipment, it will do so via access agreements allowing technically viable and cost-effective operations and maintenance of these systems.

*Selection Factors:* High quality switches and breakers, long lifetime performance, and manufacturer reputation.

*Benefits:* Simplifies the interconnection between the microgrid and the distribution utility, affords a data rich environment for the system owner and the utility as this important electrical junction.

*Challenges:* High installed capital cost.

*Design Considerations:*

- Communication protocol
- Synchronizing capabilities

*Current Resources to be Leveraged:* Automatic Transfer Switches at existing backup generators.

## **F. TE study notes:**

The objectives of a project to implement a TE micro-market would include establishing opportunities for prosumer investments and market competition. As part of its microgrid modeling and assessment efforts, the project team specified several configurations of PV, ESS, and CHP systems to meet all microgrid requirements. The optional multi-tiered energy services model (*Appendix D*) would accommodate other technology options that meet criteria for microgrid integration and utility interconnection. Moreover, a TE implementation would allow further study of opportunities for customers to engage fully in DER micro-markets, from acquiring shared solar assets to developing neighborhood storage systems.

### **3.4.2 Existing assets being leveraged**

(See 3.4.1 above.)

A general lack of suitable DERs and underground cable infrastructure in the Warwick area limits the opportunity to leverage existing physical assets. Noteworthy existing assets to be leveraged include a 60 kW PV system at the Mt. Alverno Center, and a 24 kW system at the Warwick Town Hall. The P3 will incorporate these systems into the microgrid so that they can continue generating electricity for their host facilities when the system is operating in island mode. Additionally the microgrid will maintain



existing backup generation systems at several locations (for backup only, not baseload or peaking generation generally).

### 3.4.3 Approach to generation and load balance

The project team will use a microgrid portfolio approach to select DERs for the microgrid. This approach focuses on analysis of the energy requirements of covered facilities, and is intended to achieve a close match between the DER portfolio and the electric load profile of those facilities. Instead of sizing the DER portfolio to match the sum of the peak loads at each critical facility in the microgrid, the portfolio approach allows DERs to be sized to meet the loads of these facilities almost all the time, without over-building. This approach enables the microgrid resources to serve the microgrid loads more efficiently, more cost effectively, and with lower emissions per unit of energy consumed.

Under this strategy, base-load CHP will be designed to run at design output for at least 8,000 hours per year. PV and energy storage will be integrated into the system to meet loads that vary above the base load. Energy storage systems will be specified based on their capability to change their output rapidly in response to dynamic transient conditions, perform load following, and provide an energy buffer among CHP, PV, and electric load throughout the day. (See Fig. I-B).

In terms of long-term operations and maintenance, the portfolio approach enables the microgrid to operate energy resources within their design envelope. This keeps maintenance costs and fuel costs at a minimum, and helps to lower the total cost of ownership. This design approach also incorporates active microgrid controls that enable optimal operation of energy storage, PV, and building management systems to manage load and reduce the afternoon peak load when needed.

Another element of the team's strategy for resource selection and sizing is based on the load duration curve presented in Fig. I-C. When operating in a grid-connected mode, the microgrid uses the grid as a resource to meet intermittent peak demand periods. When operating in island mode, the microgrid supply and demand will be managed through dispatching microgrid generation, load management, and minimal use of existing backup generation to sustain lower operating costs. This methodology allows the designers to evaluate the appropriate balance of grid service, generation resources, and load management capabilities. The resulting solution will be sound both technically and financially.

*TE study notes:* A TE implementation within the proposed microgrid would perform operational dispatch of resources on the basis of long-term contracts and spot transactions. For the purposes of microgrid modeling and assessment, the project team outlined operational dispatch protocols to meet all microgrid requirements. A TE implementation would allow further study of opportunities for competitive market clearing and dispatch of resources – long-term and short-term energy needs – on the basis of real-time geotemporal value to multiple resource owners.

### 3.4.4 Permitting requirements

The specified generation and storage systems will be subject to customary permitting and siting regulations, codes, and requirements.

Installation of DER and distribution hardware, cable, and gas pipeline extensions will comply with local and state review and permitting requirements, building and electrical permit requirements, and

prevailing codes such as the NYS fire code and construction loading standards. Fuel-burning systems (CHP) will be subject to standards for air emissions, noise emissions, water use, zoning, and site constraints such as height restrictions and architectural or historic preservation requirements. Project equipment specifications will require equipment to meet or exceed federal, state, or local emissions standards, as well as prevailing industry and technical standards and certifications.

### 3.4.5 Development, construction and operating approach

The project team anticipates developing, implementing, and operating the proposed microgrid using a multi-phase collaborative project approach to enterprise development and implementation. The P3 will oversee all development activities, delegating responsibility and entering contracts to plan, design, build, and commission the microgrid and related assets to serve microgrid customers, and formalizing financial arrangements to provide capital funding for all phases of development. The P3 also will oversee all operational activities, including management of customer service, energy transactions, and physical asset management. (See Fig. I-H).

The project team anticipates that microgrid engineering, procurement, construction, commissioning, financing, customer recruitment and servicing, and other enterprise activities will be performed by a combination of the project team and additional contractors, vendors, suppliers, and consultants, retained in accordance with the P3's procurement and governance policies. During initial onboarding and operational phases, P3 organization is expected to retain minimal management and customer service staff in Warwick, with operations and maintenance performed by contractors under long-term arrangements.

### 3.4.6 Community benefits (summary)

(See 3.2 and 3.2.1)

The proposed microgrid produces a wide range of benefits, as described above and throughout the Task 2 and Task 3 reports. They can be summarized as: 1) Improved resilience for critical facilities; 2) opportunities to expand local investment in renewable energy and conservation; and 3) support for economic growth and development. Additionally the team's analysis indicates the proposed microgrid can produce direct economic benefits, providing enhanced services to customers for costs that are equal to or lower than current costs.

The Warwick Microgrid is designed to serve four strategic goals: (1) Improve the resiliency of services that are critical to the health, safety, and vitality of the community; (2) Increase the community's use of local resilient renewable energy assets; (3) Reduce the community's fossil energy consumption and related environmental footprint; and (4) Support future economic development and growth by modernizing community energy infrastructure.

### 3.4.7 – Utility requirements

Utility participation is necessary to ensure the proposed project's feasibility and positive cost-benefit performance for the community. Key utility contributions include the following:

- Technical design input and guidance
- Interconnection requirements and procedural support
- Business model input and guidance

- Operating agreements
- Customer servicing arrangements

In principle the utility also may support the P3 as an equity partner, investing in or contributing distribution systems and platform assets necessary to serve microgrid customers.

### 3.4.8 DER maturity

(See also 3.4.1)

The distributed energy systems specified for the Warwick Microgrid all use thoroughly field-tested, off-the-shelf technologies. Photovoltaics, natural gas-fired CHP systems, and battery energy storage are all well-established technologies that have been proven to be effective and reliable both when installed singly and when deployed as part of a microgrid system.

The microgrid control platform also will rely on thoroughly field-tested systems. Specified microgrid control systems will support seamless transition from grid-connected to island mode, and will use distributed controls and portfolio management methodologies with demonstrated capabilities to sustain balanced operation in support of project objectives. PCC, protection, and safety systems will support all required operational requirements in compliance with prevailing utility standards (e.g., IEEE 1547).

### 3.4.9 Describe the operational scheme

Operation of the microgrid will include several key components:

A. *Metering:* The P3 will provide customer services via sub-metering arrangements.<sup>9</sup> The project team will add new sub-metering as necessary to serve microgrid customers.

B. *Technical operations:* The microgrid controls, and microgrid design, are based on the 10 ORNL microgrid Use Cases. The most important use cases address transition to an island mode (planned and unplanned) and return to grid-connected operations. Stage 2 development will include developing a detailed sequence of operations for transitioning to island and back to grid-connected mode. Under normal conditions, the microgrid will operate under one of two regimes to accommodate its nodal structure. The first regime is local (within each node) where optimization is primarily focused on assurance of reliable and resilient operations. The second regime is global – across the entire microgrid – where optimization includes economic and emissions reduction objectives. At the global microgrid level, operations are focused on savings to the community and reduction of emissions.

C. *Financial operations:* The microgrid P3 will bill system customers monthly for energy used by system resources. The project team anticipates using an ESA approach that simplifies this process, billing consumed \$/kWh monthly instead of in each of the 18+ billing determinants in a typical utility electric bill. Depending on how the P3 and operating agreements are established, the customer may also still be billed by the utility. To simplify bill management for the customers of the microgrid, microgrid service may become a pass-through within utility billing, or vice-versa.

---

<sup>9</sup> Pursuant to Public Service Law §96 approvals, HEFPA compliance requirements (§§30-53)

D. *Transaction management*: Any additional revenue to customers from shared program participation (community solar gardens, demand response, ancillary services) will be accounted for in the monthly bill that customers receive from the P3 or from the utility if bills are integrated.

E. *TE study notes*: In a TE deployment, market trading activity via long-term contracts and spot transactions would drive operational dispatch of various resources. The Warwick Microgrid could serve as a test market to demonstrate micro-market dispatch of energy resources supporting balanced and economical microgrid operation.

#### 3.4.10 Replicability of the business model

(See also 3.2.6)

The Warwick Microgrid Project establishes a highly replicable and scalable approach to providing resilient energy and other energy services for New York communities. It applies key elements that are consistent with commercial viability, technology and modernization objectives, and New York State energy policy goals.

A. *P3 ownership model*: Public-private ownership and management structures developed for the Warwick Microgrid can be used in other community microgrid situations. Additionally these structures are highly scalable, being viable and supportive for projects of various sizes.

B. *Design and technology approach*: By specifying resilient infrastructure and resources in standard configurations, and by providing controls for managing clusters and portfolios of facilities that serve community resilience, the Warwick Microgrid's design and technology approach establishes a roadmap for community resilience in New York and jurisdictions with similar market and regulatory conditions.

C. *Financing*: By structuring community microgrid agreements and covenants to support commercial financing, the project may establish programmatic financing models readily adaptable for communities with similar needs and wants.

#### 3.4.11: Describe the barriers to market entry

-and-

#### 3.4.12 Describe the plan to overcome the barriers

Several barriers require attention for NY Prize projects in general:

A. *Legacy business model*: Approaches to microgrid development that challenge traditional business models or alter customer relationships may prompt market incumbents to delay or prevent project progress.

*Proposed project solution*: The project team will define appropriate operating agreements, concessions, or exemptions, and facilitate their execution to enable project progress.

Policymakers can consider a variety of solutions to overcome these barriers for eligible projects or statewide. For example, some states are considering strategies to encourage utility support for microgrids. These include: revisions to codes of conduct that would allow utility joint venturing and alliances; policies to encourage or require integrated DER and distribution system planning; and market

access and ratemaking policies that enable competitive microgrid development – *e.g.*, adjustments to revenue-decoupling mechanisms, performance-based rate structures that reward utility support for microgrids, and Public Service Law exemptions for community microgrids. Some jurisdictions have provided alternative regulation and special legal exemptions for community microgrids and district energy projects that cross public rights of way and serve multiple customers. Such tools would substantially encourage innovation and competition in providing resiliency solutions for communities.

B. *Vulnerable resource lock-in*: Other programs and market forces encourage proliferation of non-resilient, grid-tied DER deployments that are vulnerable to outage risks. Such deployments can prevent investments in resilient assets to serve critical community facilities.

*Proposed project solution*: Encourage right-sizing of new net-metered resources to allow critical loads to be served by resilient resources.

Net metering policies in New York present a substantial problem for community P3 microgrids – especially remote net-metering policies that provide incentives for major energy customers (most notably school districts) to enter long-term arrangements under which substantially all of their utility energy purchases are offset by output from large solar arrays. Such projects tend to be developed and sited to provide the greatest economic benefits for investors and vendors, with little or no consideration for community resiliency needs or options. Because net-metering customers must continue purchasing energy from the utility in order to qualify for production credits, they are effectively excluded from any resilient energy or efficiency-improvement initiatives that would be financed on the basis of energy purchases. In effect, by locking-in facility loads for power from non-resilient DERs, remote net-metered energy projects tend to limit options and impair resiliency.

Policies to encourage investments in renewable energy and DERs in particular will yield the greatest value for customers – and the greatest resiliency benefits for communities – if they accurately attribute and monetize true geotemporal energy value. State net-metering policies bear review and revision to ensure they avoid unintended negative consequences for communities.

C. *Monetization gap*: Inadequate methodologies for attributing and monetizing the geotemporal value of DERs constrain cash flow and discourage investment in resilient assets.

*Proposed project solutions*: The project proposes three solutions to appropriately monetize DER value: 1) Microgrid resource portfolio, providing multiple modular technologies to meet a wide range of customer profiles, monetized via long-term ESA arrangements; 2) Consideration of optional multi-tiered energy services model and community choice aggregation policies to enhance local customer choice and support value-based community resiliency improvements; and 3) Transactive energy micro-market deployment, demonstrating market-clearing mechanisms to establish geotemporal DER values with long-term contracts and spot transactions.

D. *Regulatory risk*: Regulatory risk associated with REV and other New York policy initiatives, and uncertainty about market access and regulatory models, deter commitments by market participants.

*Proposed project solution*: Ensure sustained legal viability by establishing contingency options for implementation in the event of regulatory changes. Monitor regulatory developments and provide supportive policy inputs as appropriate, building upon New York customer choice, power marketing, and alternative energy policy frameworks to support a workable regulatory approach for community resilience priorities.

E. *Procurement hurdles:* Government procurement policies may compel public entities to apply competitive procurement requirements to microgrid participation, deterring early-stage commitment from qualified developers and vendors.

*Proposed project solution:* The proposed microgrid public-private partnership structure is intended, in part, to address this conflict by acting as a procurement agent for the P3's public owners and customers. This role will be most effective if the State of New York provides public entities with confidence that they can participate in the P3 and purchase energy services from the microgrid without violating procurement regulations or triggering burdensome administrative requirements.

To the degree public entities apply to microgrid services the same competitive procurement processes they use for other procured commodities and services, procurement requirements may have a chilling effect on community microgrids. The State of New York could encourage community microgrid development by providing exemptions for State-supported community partnerships or administrative guidance enabling workable procurement arrangements.

F. *Taxes and prevailing wages:* State and local taxes and prevailing-wage standards increase project costs compared to projects in some other U.S. jurisdictions.

*Proposed Project Solution:* Develop structures to capture tax benefits. Seek grant and incentive funding to support project benefit-cost potential.

High project costs effectively reduce the scope of services that a microgrid can cost-effectively provide. They also limit P3 returns and constrain access to commercial capital sources. Separate tax policy review of microgrids may ensure that taxes do not unintentionally impede mobilization of private capital for community resilience and economic development benefits.

G. *Inadequate development funding support:* In Warwick, as in many New York communities, access to development capital is severely constrained, and usually insufficient to complete advanced design feasibility analysis, engineering development, and financial and legal structuring, in preparation for construction financing. Available development capital is very limited, and communities may be compelled to abandon options for lack of early-stage support.

*Proposed Project Solutions:* Seek NY Prize Stage 2 and Stage 3 funding. Leverage complementary programs. Seek financing wrap with funding for development.

### 3.4.13 Microgrid market for this approach

(See also 3.4.10)

The community microgrid market is a small but emerging area that combines elements of the electricity, gas, and thermal energy distribution businesses together with advanced IT and control system technologies. These resources are combined to support integrated community planning initiatives. Projects in this market face unique challenges, including serving critical facilities that are not necessarily close to each other; establishing contractual agreements with a diverse set of parties; and supporting multiple strategic priorities (resilience, cost savings, sustainability) within a single system. Accomplishing all of this with proven, off-the-shelf technologies (required to achieve scale rapidly) requires innovative technical approaches and business models, deployed by experienced market players. The Warwick Microgrid project team has identified a technical approach and group of project partners that can achieve this.

With weather patterns becoming more extreme and contributing to more frequent and widespread electric outages, more communities will seek to develop comprehensive emergency preparedness plans that include community microgrids following the approach being developed for Warwick. Additionally, community stakeholders increasingly recognize the value – and difficulty – of comprehensive integrated planning and development to maximize community benefits and minimize the costs of interrelated initiatives and investments. The market for community microgrids will benefit directly from successful demonstration of development models that support ongoing collaboration and integrated planning among community stakeholders.

### 3.5 Financial viability

The proposed microgrid was designed on the basis of the following key elements necessary to support financial viability:

- The critical nature of the identified facilities to support community operations in the event a major electric outage,
- The electrical and natural gas infrastructure in the community,
- Each facility's energy requirements,
- Each facility's energy systems and infrastructure,
- Improved resiliency to withstand extended power outages,
- Increased reliance on renewable energy,
- Improved emissions footprint, and
- Supply of energy at a competitive cost

The design incorporates the installation of new DERs including CHP, PV, and ESS technologies. Other microgrid resources include the conventional electric grid, energy efficiency measures, and load control strategies, supported by existing backup generators equipped with automatic transfer switches. The overall system sizing provides for meeting the baseline energy requirements of the facility with DER, energy efficiency measures, and utility grid resources. The proposed design will deliver approximately 7.5 million kilowatt hours of energy per year from microgrid DERs.

At this phase of project assessment, a high-level project budget was developed and incorporated into the sizing model to ensure that the design meets both the technical and economic elements of the project. Cost elements include engineering, permitting, capital equipment, site preparation, construction, controls, start-up, commissioning, and training. Site preparation also includes the addition and modification of electrical infrastructure for undergrounding distribution lines, PCC controls, monitoring, and protection equipment. Some of these infrastructure costs may be paid to the electric utility. The estimated project budget for this project is \$6 million with an accuracy of +/- 25%. *Note:* This cost includes an applicable deduction for the federal investment tax credit, which recently was extended by the U.S. Congress. The project cost excludes any other incentives that may be applicable to the project. Nevertheless, the team anticipates efforts to take advantage of all applicable incentives for the project, including NY Prize Stage 2 and Stage 3 awards. These potential incentives are addressed in section 3.5.2 of this report.

The proposed microgrid creates savings for the community in the form of customer energy cost savings, resiliency savings, and carbon savings due to GHG reductions. Resiliency savings include likely business costs saved by avoiding anticipated outages. GHG savings are generated as the proposed system would

produce fewer tons of greenhouse gases each year, due to an emissions profile that is much cleaner than that of the utility. The value of GHG reductions is based on the U.S. Environmental Protection Agency’s CO<sub>2</sub> offset price of \$40 per ton. A summary of the estimated microgrid savings for the first full year of operation of the proposed microgrid are presented in Fig. 3.5-A:

**Table III-H: Estimated Microgrid Year 1 Savings**

<b>Estimated Annual Energy Savings</b>	\$131,000
<b>Estimated Annual Resilience Savings</b>	\$647,000
<b>Estimated Annual Carbon Savings</b>	\$110,000

This report proposes a business structure in which the microgrid would be owned and operated by a P3 entity that would arrange funding for the project. The P3 would generate revenue through energy service agreements for a 25-year period. The economics of the project have been analyzed using a life-cycle cost analysis. This analysis shows that the project has a positive net present value (NPV) and an unlevered internal rate of return (IRR) of 7.6%. Based on experience with the investment community, this unlevered IRR is sufficient to support commercial financing.

Based on the estimated energy savings, assumed project financing costs, and the 25-year contract term, the study indicates that a 7 to 10% cost savings can be achieved, compared to the current blended electric rate of the included facilities of \$0.129 /kWh.

*TE study notes:* The proposed financial structure could be adapted to be consistent with a potential TE micro-market deployment in the project area. In terms of financial viability, a TE approach would be expected to improve financial performance by providing customers with greater optionality. Long-term contracts would preserve the core financial proposition while spot-market transactions allow counterparties to pay or earn the geotemporal value of resources.

### 3.5.1 Categories and magnitude of revenue streams to the owner

The proposed microgrid is expected to produce between \$900,000 and \$1.2 million in annual revenues, all in the form of electricity sales to microgrid customers. Additional revenue streams to the microgrid P3 were not modeled for the current phase of project development. Such revenue streams may include electric energy, capacity, demand response, and ancillary services sales in the NY ISO wholesale market; revenues from related energy resource investments, including potential regional biomass production businesses; energy savings performance fees and bonuses; and consulting and service fees.

*TE study notes:* A TE micro-market would enable participants to execute their own resource investment and operation strategies to serve their own objectives as asset owners. As a result, the decisions of TE market participants may affect total microgrid revenues. A TE deployment would enable further study of how micro-market behavior might affect overall system economics including revenue streams to prosumers and P3 owners.

### 3.5.2 Other incentives identified

The project would seek to leverage various incentive programs and similar initiatives to support investments in resilient DERs and related systems and infrastructure. Examples may include:



- A. *Federal incentives*: Federal investment tax credits, production tax credits, and accelerated depreciation provisions
- B. *NYSERDA programs*: NYSERDA K-Solar, NY Sun, BuildSmart NY, New York State Community Partnership, and Combined Heat and Power programs
- C. *NYPA programs*: NYPA Energy Efficiency, NYPA Solar MAP programs
- D. *Other NY programs*: Energize NY PACE Finance, New York Green Bank support, Community Choice Aggregation
- E. *Utility programs*: Orange & Rockland high-efficiency appliance rebate programs (as applicable)\*
- F. *Other potential incentive programs* supporting ESS and electric vehicle (EV) charging and vehicle-to-grid system investments (ChargeNY, Clean Fleets NY)

*Note*: The proposed microgrid does not rely on Orange & Rockland net-metering provisions for any resources dedicated to serving critical facilities. The microgrid P3 may seek to integrate energy outputs from certain existing or new net-metered solar installations that are owned or contracted by microgrid customers. Additionally, if current New York PSC deliberations yield a Community Net Metering program that is consistent with project objectives, the microgrid P3 may seek to structure qualifying project assets for inclusion in such a program to increase system value to the community.

### 3.5.3 Categories of capital and operating costs (fixed and variable)

**Table III-I: A: Operating cost categories**

Operating cost	Fixed, variable, or both
Finance payments	Fixed
Commodities	Both
O&M	Both
Equipment replacement	Variable
Enterprise*	Fixed

\*Administration, management, customer service, and legal costs.

**Table III-J: Capital cost categories**

Capital cost	Phase
Design, engineering, and development	Deployment
DER equipment	Deployment
Distribution equipment	Deployment
Microgrid controls	Deployment
Equipment additions and upgrades	Operation

### 3.5.4 Ensuring profitability

Ultimately, the project’s profitability will derive from the value it produces for the community. The proposed ownership model ensures profitability by defining required microgrid resources and establishing a financing model that supports ongoing positive cash flow in excess of debt service and operating expenses.

### 3.5.5 Describe the financing structure

The financing strategy for the project will be built on accessing private capital to supplement public capital sources for project financing. For example, tax credits and depreciation can provide access to equity and debt funds from private investors to carry qualifying tax benefits and liabilities. However, the P3's modest expected financial returns likely will limit access to some forms of commercial financing, necessitating a hybrid public-private financing structure. The public owners who support the P3 can access tax-exempt public capital sources, potentially including municipal bonds and federally insured public infrastructure development funding. Public entities with tax authority can also facilitate access to property assessed clean energy (PACE) funds for qualifying energy improvements. Grant funding (potentially including NY Prize Stage 2 and Stage 3) will reduce project debt costs and further leverage P3 equity contributions. Each type of financing may contribute to a cost-effective capital financing strategy for the project, seeking to lower the capital costs of financing for the benefit of community taxpayers.

Generation management would be separated from ownership of the wires, T&D and operating facilities for regulatory purposes and to facilitate better access to capital and management of different risk profile assessments for the project. Important consideration exists for monetizing different value streams from the projects to facilitate financing, the ability to retire debt service, and to provide equity returns. Perhaps, system benefit charges could be expanded to provide recognition of resiliency benefits created by the project. PACE financing and green bonds with local tax authorities would offer an appropriate supplemental source of funding. Finally, tax-increment financing (TIF) may need to be considered with bonds for resiliency improvements in the underlying real estate properties.

Reductions and lower costs from the project and incremental value streams can be coordinated with the amortization schedule associated with the repayment of debt. At a minimum, that debt repayment would need to exceed the tax recapture period of five years from the microgrid's placed-in-service date.

Community microgrids apply a variety of technologies to maintain balanced operation. As a result they pose related challenges and risks. Vendor agreements for the project should address foreseeable issues, including performance guarantees, warranty repairs and replacements, and security implementation. Particularly in the areas of cybersecurity, energy storage, and control systems, project architecture and design should anticipate technology changes to avoid stranded assets with underlying microgrid investments. These risks should be covered in upgrades for software agreements with vendors.

The critical financing risk will be design and construction of the microgrid project. The microgrid P3 would assume the responsibility to access capital and provide construction-period risk coverage. This could be managed in the ownership structure by use of a trust whereby the microgrid distribution platform users would be part of that trust, and the generation provider and ESCO would have contracts with that trust for services. This might also separate legal title from beneficial title to project assets for regulatory purposes and facilitate refinancing or exit strategies in the financing structure for the project.

Sources of debt financing for the project may be arranged through the NY Green Bank as well as existing bond programs. The financing resources covered in this review raise important issues regarding equity financing – specifically gaining access to risk capital, to reduce and ultimately eliminate reliance on scarce public debt and development capital.

Economic constraints for municipal projects likely will limit implementation of microgrids in the short term without additional funding support from federal, state government, or other county and local entities. The true test of microgrids will be their ability to attract private capital. The NY Prize projects could assist the private financing markets by disseminating substantive, objective information and tools to support access to private capital. Communities could benefit the most from guidance and technical assistance that encourages market-based project assessment and development. Removal of artificial regulatory barriers and a consistent planning horizon for microgrids for the next decade will also be critical. This will likely be experienced in the marketplace upon refinancing of these projects and over the next five years, once the NY REV outcomes are implemented and new business models are established.

Financing challenges and risk management for microgrids exist based upon five critical factors arising in ownership and financing structures:

- (1) Multiple technologies used in the microgrid are different from existing financial structures that focus on individual types of generation. Microgrids are multidisciplinary, integrated, involve generation, transmission and distribution to incorporate and aggregate towards linking one or more generation technologies with T&D services.
- (2) Multiple credits for financing risk are presented for an evaluation while existing tools for financing projects are structured around certain types of customers, buildings, and generation technologies. Microgrids likely may serve a network of all customer types within the community from residential and commercial to MUSH markets, and industrial users all with different levels of individual credit evaluations required.
- (3) Microgrids add complexity, which may generate requirements for a credit wrap or guarantee to support access to capital for successful project financing.
- (4) Multiple revenue sources are presented around benefits of the microgrid including reduced energy costs, declining GHG emissions, energy security, grid hardening, and reliability. New York is characterizing these benefits in five different ways. Energy savings alone may not pay for the cost of the microgrid investment. The benefits may command a premium, which the utility or the overall system may not be willing to provide. Further work on quantifying value streams needs to be done within New York to support successful microgrid development building upon reviews of value added by solar energy, storage, CHP, and microgrid controls. These should not be left to one-off negotiations with franchised utilities, because a stable revenue framework with quantifiable benefits needs to be structured to enable innovation and competition to flourish throughout the state of New York.
- (5) Microgrids often are presented as individual customer solutions. Making microgrids economical as a matter of scale raises demand- and supply-side analysis in support of financing. When aggregated together, microgrid customers must have a demand profile that supports the operating requirements of the generators that will be providing power resources to the microgrid system.

Thoughtful analysis of these considerations will be critical to support final choices in financing strategies from the array of financing tools available to the projects.

### 3.6 Legal Viability

The legal viability of the proposed microgrid depends on factors that require resolution in Stage 2:

A. *P3 and BOT ownership structures*: The viability of proposed ownership structure and asset-transfer concepts must be validated through Stage 2 collaboration with prospective P3 owners and Orange & Rockland. Orange & Rockland is reviewing the microgrid P3 and BOT structure plans. The project team anticipates resolving related issues by establishing operating agreements with the utility, and by seeking administrative guidance from the New York Public Service Commission.

B. *Public Service Law and Orange & Rockland franchise*: Key legal issues may involve New York Public Service Law and utility franchise enforcement as applied to community microgrids serving multiple customers and crossing public rights of way. The team anticipates addressing such legal issues in Stage 2 through development of detailed operating agreements, concessions, State administrative guidance, and other requirements for project progress in Stage 2.

C. *Approved procurement policies*: An operating methodology is required for the P3 to serve as a public-customer procurement agent for microgrid services. The project team anticipates collaborating with the proposed microgrid's public-entity owners and customers to establish procurement practices and policies that address applicable procurement requirements. The project team also may request State guidance to establish a workable procurement agency approach that can be replicated in other P3 and similar microgrids serving public entities.

### 3.6.1 Describe the ownership structure

(See also 3.3.3)

#### **A. Microgrid Public-Private Partnership (P3)**

The project team anticipates that the proposed Warwick Microgrid will be owned and operated by a public-private partnership, combining private business and public organizational models to enable integrated planning, ensure strategic focus on community objectives, and provide access to a full range of funding options (see Fig. III-A). The P3 approach provides a comprehensive but flexible structure enabling the community to leverage investments that best support resiliency for critical services, while improving the community's energy and environmental infrastructure and supporting ongoing economic development. The team anticipates the P3 ownership structure will be formalized in Stage 2.

#### **B. Build-Operate-Transfer Model**

The project team proposes a build, own, operate and transfer structure. A BOT is a P3 project model in which a private organization conducts a larger development project under contract with a public sector agency or quasi-public entity, such as a franchised utility. A P3 can develop a larger public infrastructure project while accessing private funding in the capital stack for the project. The SPE formed to manage the construction, design, EPC, and operations of the project would be structured with separation of generation ownership from actual project wires, T&D system investment, and operational services so that the two value streams from ownership are independent for regulatory purposes. (See Figs. 3.6.1-A and -B)

For the proposed project, the SPE would be a P3 formed by the identified public-sector and private-sector partners, to establish the capacity and expertise required to execute the project strategy. To the greatest degree possible, the SPE will draw subject matter expertise (SME) from its partners to ensure the likelihood of success in designing and implementing the vision of the community. Public-sector

partners may offer limited amounts of funding, capital asset contributions, or some other benefits, such as certain tax exemptions and access to municipal policy and bonding authority. The private sectors partner assume most of the risks associated with planning, constructing, operating, and maintaining the project for a specified period of time. This structure would at least cover the period of tax recapture for some project tax benefits,<sup>10</sup> and would allow construction and operating risks to be properly allocated, with the possibility of an exit strategy preserved in the project structure.

During operational phases, the P3 charges customers in the community who use the microgrid infrastructure, which has been financed to realize a return on investment, cover debt service, and provide a reserve for operations and maintenance. At the end of the term in the project structure, the P3 partners would transfer ownership in transferable assets to the funding organization, either freely or for an amount stipulated at fair market value for the project, or the project could be refinanced for a further term. Variations on this structure include: (1) build, own, transfer (BOT); (2) build, own, operate (BOO); (3) build, lease, transfer (BLT) and build, lease, operate, transfer (BLOT), depending upon the unique needs of the community.

Ownership structure significantly affects cost recovery for debt service and financing and the ability to monetize the benefits from the microgrid. This ownership structure for microgrid projects is intended to promote higher levels of cost savings to customers and to ensure that microgrid design and implementation prioritizes community priorities to increase local resilience, penetration of renewables, demand-side management, energy storage, and energy efficiency.

A BOT structure and process for the proposed project is summarized as follows and in Fig. III-B and III-C:

- a. Pre-Transfer: The microgrid public-private partnership (P3) will be responsible for all development, financing, design, construction, integration, and operations tasks associated with the microgrid. Its scope, function, and legal basis will be defined by mutual agreement.
  - i. Operational Divisions: Through the course of project development and implementation, the microgrid P3 will fulfill its obligations through two distinct operational divisions – Division A) Microgrid Platform and Division B) Microgrid Energy Services.
  - ii. O&M Obligations: The microgrid P3 will retain responsibility for operations and maintenance of commissioned assets during the agreed term. O&M is expected to be provided on a long-term performance-contract basis.
  - iii. Legal and Financial Obligations: In general the microgrid P3 will bear regulatory and fiduciary responsibility for performance and delivery of microgrid services in accordance with service agreements and cleared market terms, when applicable.
- b. Post-Transfer: At the end of the agreed term, the microgrid P3 will transfer the assets and obligations of Division A) Microgrid Platform to a DSPP. The microgrid P3 will retain ongoing ownership and obligations for Division B) Microgrid Energy Services. The DSPP will operate Division A as a regulated utility asset. The DSPP will be responsible for obtaining PSC approval for tariffs or service fees charged to recover utility costs associated with microgrid Platform operations.

---

<sup>10</sup> Tax credit and accelerated depreciation provisions specify five years of ownership at a minimum, except for certain biomass assets which are depreciated in no less than seven years. (*IRS Section 179 – MACRS for listed property*).

Fig. III-C: BOT microgrid - Post-Transfer Ownership Structure

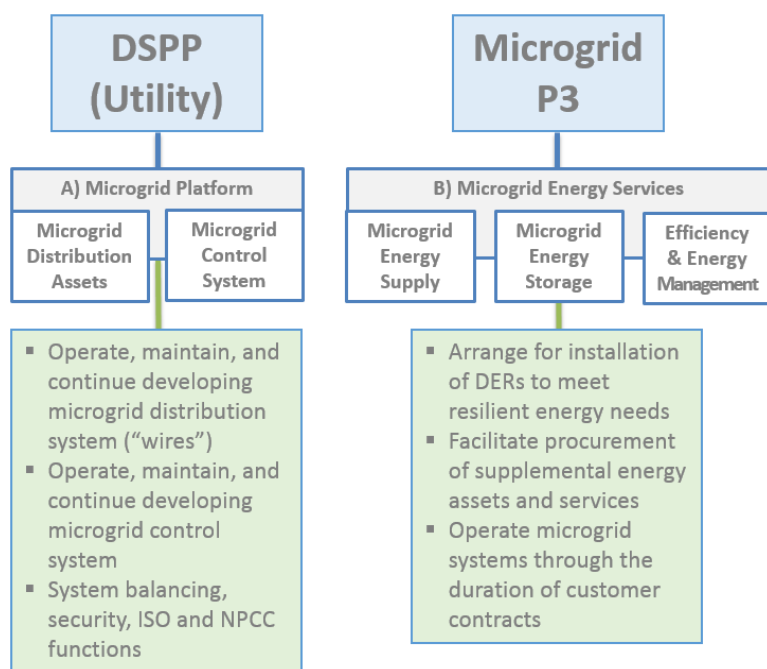

### 3.6.2 Project owner and approach

(See 3.3.3)

The project team has discussed options for ownership participation in the microgrid P3, but formal agreements have not been entered. The project team anticipates continuing its involvement at the request of the charter members of the public-private partnership. In general:

Table III-K: Microgrid P3 charter partners

Category	Prospective Partners
<b>Public</b>	Town of Warwick, Village of Warwick
<b>Local Private</b>	Bon Secours Charity Health System and individual businesses, institutions, and residential co-owners of microgrid resources
<b>Nonlocal Private</b>	Microgrid Institute, Hitachi, Orange & Rockland Utilities, third-party investors

### 3.6.3 Microgrid assets and P3 owners

(See Fig. III-F)

Any entity could, in principle, hold a stake in a public-private partnership in some form. Two primary public owners are identified, with critical facilities as described:

- Town of Warwick: Water and wastewater facilities; Town Hall, Police Station, and Senior Center (emergency shelter); DPW facilities with onsite fuel supply for service vehicles.

- Village of Warwick: Water and wastewater facilities; Village Hall.

Other microgrid customers that in principle could own assets used in the microgrid:

- Bon Secours Charity Health System – St. Anthony Community Hospital, Mt. Alverno Center, Schervier Pavilion
- Warwick Fire District – Three fire stations housing five separate fire companies
- Warwick Ambulance Corps – Community rescue squad facilities
- Prospective local energy customers with microgrid-controlled onsite DERs and shared microgrid generation assets

#### 3.6.4 Data security and privacy

Customer information is subject to best practices and industry standards for privacy and security, as well as data-retention policies. Systems for data entry, access, and storage will be designed to ensure cybersecurity and physical security against intrusion, unauthorized use, and data loss.

The proposed project customer service specifications include full-scope security, privacy, and data management policies.

## Section IV:

### Task 4: Benefit-Cost Analysis

The project team developed a general budget for the Warwick Microgrid project and incorporated it into the technical model to ensure that the design meets both the technical and economic requirements of the project. This budget includes costs for engineering, permitting, capital equipment, site preparation, construction, controls, start-up, commissioning, and training. The cost associated with “site preparation” includes the addition and modification of electrical infrastructure, PCC controls, monitoring, and protection equipment. Some of these infrastructure costs may be paid to the electric utility. The estimated project budget for this project is \$12 million with an accuracy of +/- 25% (within the +/- 30% range set by NYSERDA). This cost includes all applicable deductions associated with the federal investment tax credit (ITC) that was extended by the U.S. Congress in 2015. This cost does not include other incentives that may be applicable to the project that will be applied during the detailed analysis in Stage 2. *(See the project Task 3 report.)*

The outputs of the technical modeling process described above were used to evaluate the financial viability of the proposed microgrid from two perspectives. First, the project team analyzed the financial strength of the project when deployed using the proposed public-private partnership business model. Under this model, the project is funded with local and third-party investment and debt. Costs of invested capital are recovered through power purchase agreements (PPA) with each customer served by the microgrid.

In addition to the project team’s financial feasibility analysis, NYSERDA contracted with Industrial Economics Inc. (IEc) to perform benefit-cost analyses for all 83 NY Prize Stage I projects. The focus of this analysis is to evaluate the societal benefits of the proposed microgrids, including benefits from emissions reductions, cost reductions, and resilience improvements. *(See “Appendix E – IEc Business-Cost Analysis.”)*

**Business Model Financial Results:** Under the proposed business model, a P3 special-purpose entity would fund all development and construction of the microgrid, own and operate the assets, and sell the energy generated from the microgrid to community customers through PPAs. The community would incur no costs to build the project – except those that P3 participants wish to invest, including in-kind and real assets and cash – and would receive all of the benefits of cost savings, improved sustainability, and energy resilience against outage risks. Community stakeholders have indicated that P3 ownership of the microgrid is currently the preferred ownership structure. The current weighted electric rate of the key critical facilities included in the proposed microgrid is approximately \$0.129/kWh. Based on the estimated energy savings, assumed project financing costs, and the 25-year contract term, the study supports a PPA electric rate with an electric cost that represents an average discount of approximately 7% to 10% for the facilities in this project.

**Benefit-Cost Analysis Results:** NYSERDA contracted with IEc to conduct a benefit-cost analysis. The project team provided detailed information to IEc to support this analysis. IEc ran one scenario for this proposed microgrid. The scenario modeled no power outages, and evaluated the grid-connected mode of operation. This evaluation yielded a positive benefit-cost ratio (1.2). As a result, IEc did not need to



evaluate additional outage scenarios in order to establish the economic break-even point (1.0) for the project. The IEC cost-benefit results are presented in Table 3.

**Fig. 4-A: IEC Cost Benefit Analysis Summary**

ECONOMIC MEASURE	EXPECTED DURATION OF MAJOR POWER OUTAGES	
	SCENARIO 1: 0 DAYS/YEAR	SCENARIO 2
<b>Net Benefits - Present Value</b>	\$3,710,000	Not Evaluated
<b>Benefit-Cost Ratio</b>	1.2	Not Evaluated
<b>Internal Rate of Return</b>	10.1%	Not Evaluated

Figure 4-A summarizes the estimated net benefits, benefit-cost ratios, and internal rates of return for the scenarios described above. The results indicate that if there were no major power outages over the 20-year period analyzed (Scenario 1), the project’s benefits would exceed its costs by approximately 20 percent (1.2/1.0 ratio). Appendix E provides additional detail on these findings.

The IEC benefit-cost analysis differs from the financial feasibility analysis performed by the project team in several ways. In addition to the differing objectives of these two analyses, the underlying assumptions used in each also differed. A few of these differences affected the comparative results of these analyses in significant ways, including:

- Gas rates used in IEC’s benefit-cost analysis were based on a statewide average for commercial end-use customers. By comparison, the rates used in the Warwick Microgrid financial feasibility analysis are based on Orange & Rockland’s distributed generation rate. This resulted in year-1 gas rates of \$6.34 for the benefit-cost analysis, and \$5.90 for the project team’s financial feasibility analysis. If Orange & Rockland’s distributed generation rate were applied to the benefit-cost analysis, net benefits would increase by \$130,000.
- The financial feasibility assessment incorporates the tax benefits of the federal Investment Tax Credit, whereas the benefit-cost analysis does not. This benefit would reduce the capital cost of the project by approximately \$1.67 million.
- Capital replacement costs used in the BCA were calculated as full-replacement costs, whereas the project team assumed a “rebuild” cost lower than the full cost of replacement (assuming continued use of existing assets where feasible). The rebuild cost for the Warwick Microgrid is \$426,000 less than the full cost of replacement.
- The benefit-cost analysis derives a price for electricity based on average wholesale energy costs, whereas the financial feasibility assessment evaluates the savings to the community based on actual costs paid by community participants.
- The period of analysis in the benefit-cost analysis is 20 years, whereas the project’s proposed P3 ownership model is based on a period of analysis of 25 years.

## Lessons and Recommendations

**Lessons Learned:** The project team encountered several key challenges – some of them anticipated, some not anticipated.

Expected Challenges	Solutions	Lessons
Obtaining facility and load data	Standard template approach; persistent outreach; team site inspections; equivalent facility estimates for unavailable data	Budget substantial time and resources for stakeholder outreach and data gathering
Maintaining engagement among diverse stakeholder group	Regular project updates; follow-up outreach; thoughtful messaging; assistance from key stakeholders; site visits	Plan to provide project information for stakeholders in various forms and venues
Designing cost-effective solution meeting all customer requirements	Microgrid design and technology expertise; rigorous system modeling and financial analysis using state-of-the-art systems	Budget substantial time and resources for iterative modeling and analysis
Gaining utility support for alternative service models	Develop solutions that produce utility benefits	Engage utility as stakeholder; confirm utility support for community goals and project/program objectives; engage utility separately in design approach
Procurement requirements among public entity stakeholders	Determine requirements and develop processes to meet agency policies	Anticipate requirements and expectations among stakeholders

Unexpected Challenges	Solutions	Lessons
Vulnerable resource lock-in (e.g., <i>critical loads that are committed under long-term contract to purchase energy from non-resilient sources</i> )	Develop alternative service models for locked-in loads	Expedite inquiries re: plans for remote net-metered systems and other commitments to purchase energy from non-resilient sources; encourage integrated development of resources to maximize resilience; inform stakeholders that locked-in critical loads will limit resiliency options and impose cost premiums; restructure remote net-metered energy agreements if possible to support microgrid design
Ongoing changes in community plans	Adaptive design and technology approach; ongoing engagement; sustained focus on project objectives	Plan for dynamic planning basis and numerous midstream changes

**New York State Policy Recommendations:** Sections of this report dedicated to subtasks 3.4.11 and 3.4.12 describe seven specific barriers to development of community microgrids (*e.g.*, legacy business model, vulnerable resource lock-in, monetization gap, regulatory risk, procurement hurdles, taxes and prevailing wages, and inadequate development funding support) and offer prospective solutions, including policy recommendations where appropriate. The following comments highlight and expand on policy issues and recommendations that the team has identified as most important to facilitate future deployment of community microgrids.

1) **Inadequate development funding support:** Community microgrids tend to be complex projects serving multiple purposes and involving numerous stakeholders with competing strategic interests. Two serious consequences arise from this fact: first, projects require a sustained, long-term focus on serving disparate and evolving strategic objectives; and second, development and engineering costs represent a disproportionately large share of total system investment costs.

Communities generally lack the in-house technical expertise and long-term project management capacity necessary to execute such complex, integrated projects. Such expertise and capacity can readily be procured from third-party entities, but communities generally lack development capital to support such contracted services.

NY Prize funds notwithstanding, communities need greater access to grants and loan guarantees that can be applied to wide-ranging community clean energy and resiliency efforts. Existing programs are too narrowly focused, with short timelines and administrative restrictions, to support communities' needs for energy planning and project development requirements. Such lack of readily accessible and flexible funding deters many communities from integrated strategic energy planning and execution.

*Solutions:* Establish programs to support community energy planning and integrated community resiliency development, including annually renewed grants for early-stage assessment, development, design, and engineering, and loan guarantees and special development district financing (*e.g.*, property assessed clean energy (PACE) bonds).

2) **Legacy business model:** Approaches to microgrid development that challenge traditional business models or alter customer relationships may prompt market incumbents to delay or prevent project progress. The New York Reforming the Energy Vision (REV) initiative has established a market-leading framework for envisioning and implementing new approaches to providing energy services. To the degree the State of New York implements regulatory options that allow communities to pursue alternative service arrangements, the REV process will enable community microgrid development. Contrariwise, to the degree it limits options to those that reinforce legacy business models, the REV process will maintain key regulatory barriers that impede community microgrids. *Solution:* Define appropriate operating agreements, concessions, or exemptions, and facilitate their execution to enable project progress. Establish roles for franchised utilities that enable their beneficial involvement without impeding communities' access to innovative technologies and competitive service options.

3) **Vulnerable resource lock-in:** Net-metering policies that provide incentives for grid-tied DER deployments that effectively bind customers to purchasing utility power that is to be offset by net-metered renewable resources. Such a structure can diminish community resiliency when net-metered generation is deployed to offset the electricity purchases of critical-load customers, but isn't available to serve critical loads during an outage in the local distribution network. Noteworthy examples encountered by the project team include school districts entering remote net-metering contracts that offset substantially all of the school district's energy purchases, limiting the cost effective addition of resilient energy supplies on-site for school district facilities that can serve as public shelters. *Solutions:* For a given project, stakeholder collaboration is necessary to define resiliency objectives, identify

options, and develop appropriate solutions to ensure that net-metered resources are designed and contracted in ways that support community resiliency and do not diminish it. Additionally, New York State policies could be revised to encourage investment in resilient DERs and discourage vulnerable resource lock-in. Specifically, New York could:

- a. Define microgrids as a special class of asset that blends renewable and non-renewable DG with storage and demand resources;
- b. Provide simplified and more flexible treatment of those resources, especially for purposes of net metering;
- c. Establish higher net-metered facility caps for qualifying community microgrids;
- d. Establish allowances for blended assets to explicitly allow full credit for the renewable output in the net-metering statute;
- e. Change net-metering policies to allow re-marketing of non-resilient net-metered resources to non-critical customers on equivalent financial terms, freeing critical loads for service by resilient resources;
- f. Establish bonus incentives to encourage deployment of resilient resources to serve loads deemed critical to communities. (Such incentives would reduce the economic penalty of the interconnection, protection, and energy management systems necessary to enable safe and stable islanding – a key factor that deters net-metering customers from investing in resilient resources.); and
- g. Structure net-metering policies to discourage, restrict, or prohibit long-term agreements that bind critical loads to non-resilient resources.

4) **Procurement hurdles:** Government procurement policies may compel state entities to apply competitive procurement requirements to microgrid participation. Differing requirements among various stakeholders create complexities and conflicts among participants, and some procurement requirements can deter early-stage contributions from qualified developers and vendors. For example, to the degree communities expect vendors and service providers to bear a portion of the risks and costs of early-stage development, communities' options will be limited to those few providers positioned to bear such costs and risks – and they may demand reimbursement for cost-shared contributions in the event they are not selected for a deployment contract. Such outcomes can yield project arrangements designed to prioritize the financial objectives of vendors and service providers, rather than the objectives of community stakeholders. *Solution:* Solutions to 1), above, can provide communities with greater flexibility to pursue alternatives optimized for their purposes. Also, a project consortium may be structured to perform as a procurement agent for the community microgrid's public owners and customers. Such a role will be most effective if the State of New York provides public entities with confidence that they can participate in joint procurement arrangements without violating regulations.

**Warwick Microgrid Project Recommendations:** The results of the project team's feasibility assessment, as well as the IEC cost-benefit analysis, indicate that proposed Warwick Microgrid project would be a technically and economically feasible solution. It would address the six community goals identified for the project, and it would satisfy the technical and economic criteria described by NYSERDA for the NY Prize program.

Additionally, the proposed microgrid would establish a replicable and financeable structure for community microgrids that could be applied to other communities throughout the state of New York. Specifically, it would demonstrate a scalable and flexible public-private partnership (P3) ownership model; a multi-tiered service model that can be adapted for use in any community with similar strategic

goals; a design and technology approach capable of providing resilience for critical facilities throughout a community; a financing approach that establishes standard covenants and structures capable of attracting both public and private commercial financing; and an integrated community planning approach that efficiently addresses both immediate and long-term community needs.

As a result, the project team strongly supports continued development of the Warwick Microgrid, and anticipates working with community stakeholders to prepare a NY Prize Stage 2 application for this project.

-END TASK 5 REPORT-

# Appendix A: Warwick Microgrid Layout Diagram

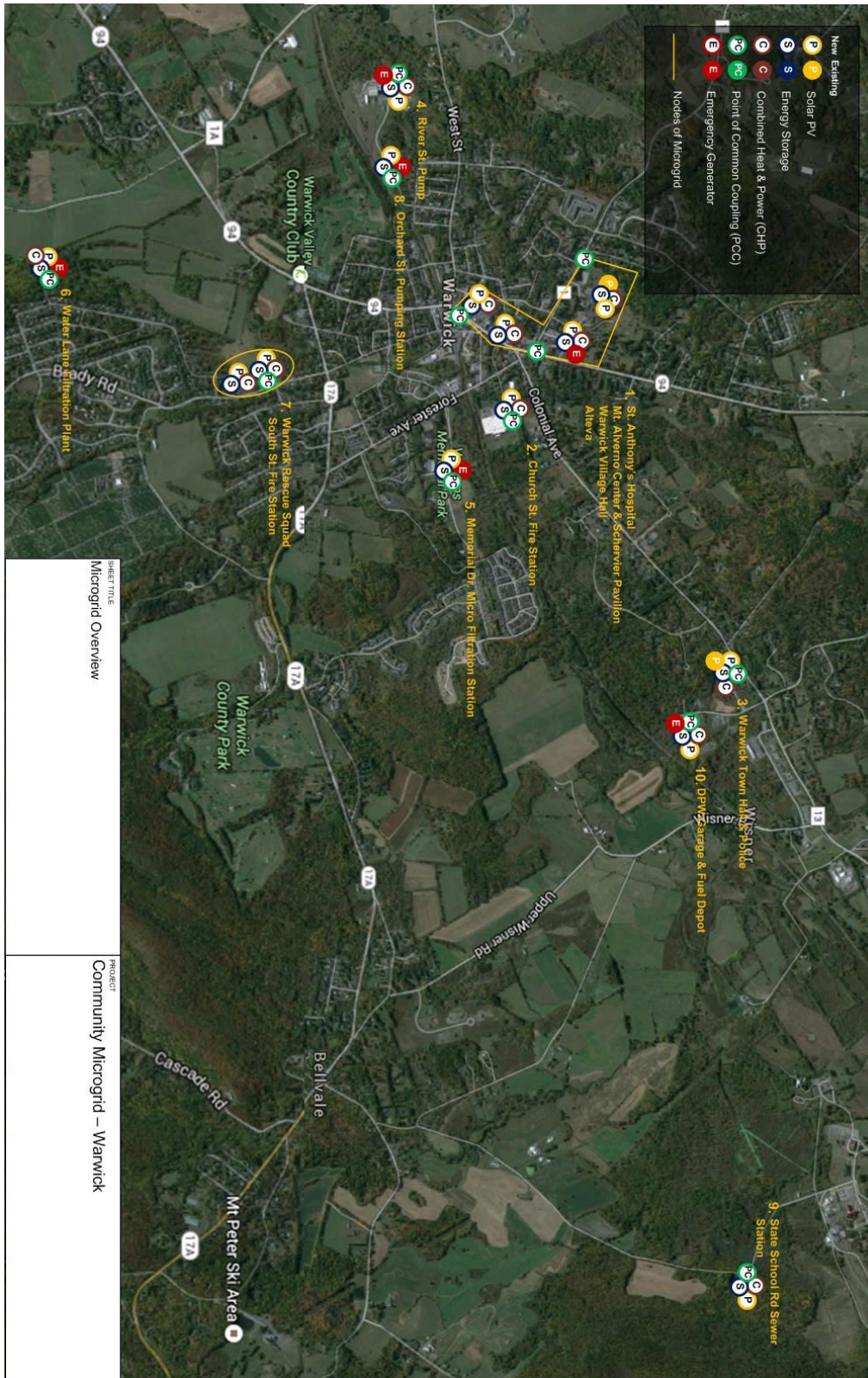

SHEET TITLE  
Microgrid Overview

PROJECT  
Community Microgrid – Warwick

# Appendix B: Warwick Microgrid One-Line Diagram

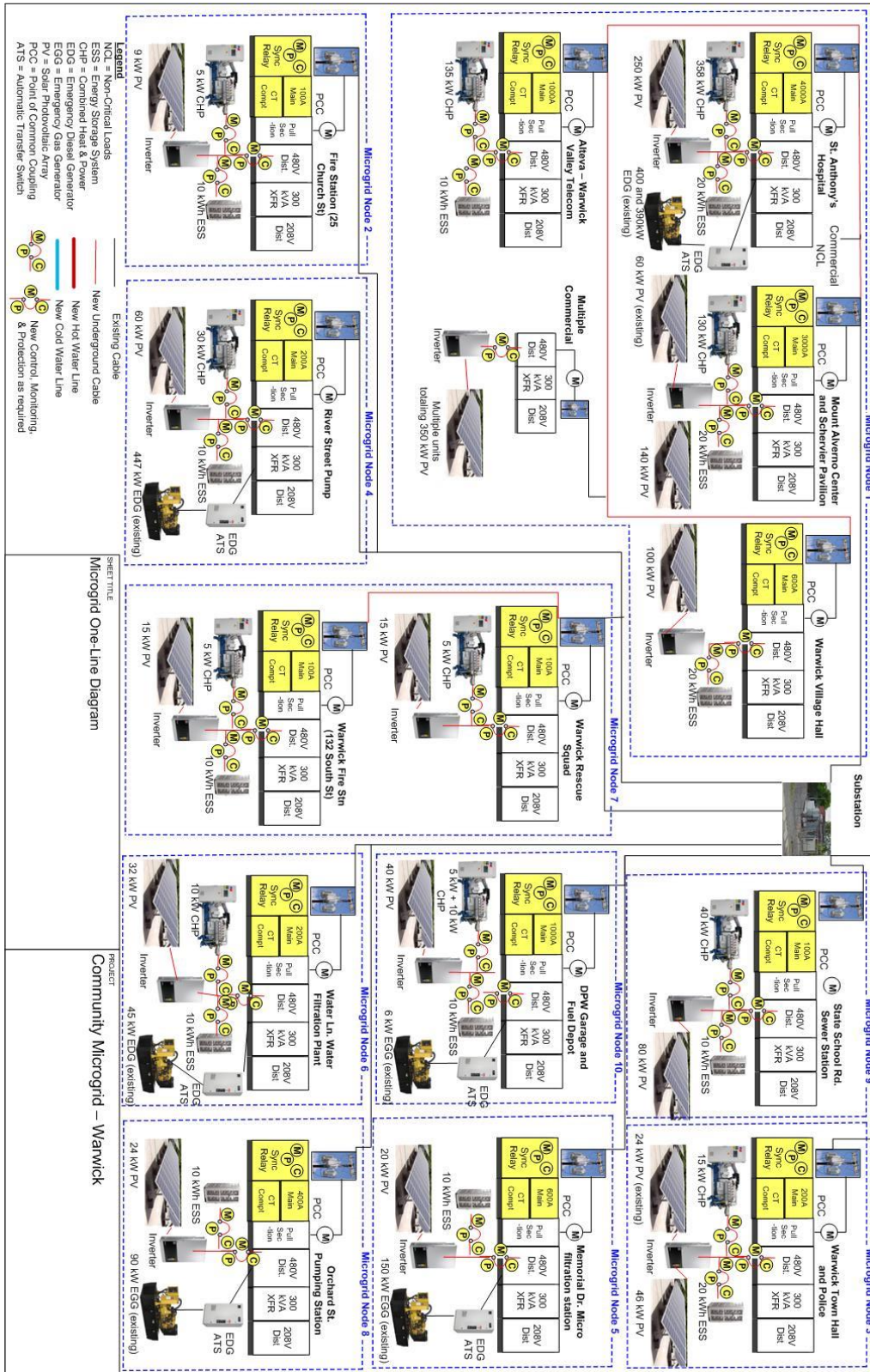

## Appendix C: Customer Viability Methodology

Microgrid Institute’s customer viability screening matrix allows quantitative evaluation of customer prospects, considering economic, technical, legal and market, and process factors, as well as other criteria. Each of the proposed microgrid’s customers is assigned estimated values for numerous factors, including: Needs and wants; Financial support options; Current energy supply arrangements; Credit strength; Thermal loads & load profiles; Existing infrastructure; Energy efficiency upgrade options; Siting & permitting; Local energy resources; Technology solution options; Regulation and policy context; Utility support for project objectives; Market costs for alternative services; Clarity of sponsor authority; Level of sponsor support; and Integration factors.

The Microgrid Institute Matrix can produce variable weighted outcomes to reflect priority focus. For NY Prize Stage 1 feasibility analysis, the analyzed results were unweighted to support conservative assessments of viability. Customer viability ratings would be higher if the Matrix values were weighted to prioritize critical facility resilience, then environmental and economic objectives second and third, as per community goals.





**Warwick Microgrid**

Customer Viability Matrix - 1/11/2016

CUSTOMER	Viability Grade (A-F)	Viability Rating (1-5)	Economic Factors				Technical Factors				Legal & Market Factors			Process Factors			Other Factors								
			Needs and wants	Financial support options	Current energy supply arr.	Credit strength	Thermal loads & load profiles	Existing infra.	Energy efficiency upgrade options	Sting & permitting	Local energy resources	Technology solution options	Regulation and policy context	Utility support for project objectives	Market costs for alternative services	Clarity of sponsor authority	Level of support	Integration factors	Bonus criterion	(Describe bonus criterion)					
<b>CRITICAL / VITAL FACILITY CUSTOMERS</b>																									
Town of War/B	3.68	3.50	3	3	4	4	1.50	0	1	2	2	2	2	3.00	4	2	3	3.33	4	4	2	2.00	2	Policy/mortuat	
Village of War/B	3.61	2.50	1	1	4	4	1.33	0	0	2	2	2	2	3.00	4	2	3	4.00	4	4	4	4.00	4	Policy/mortuat	
Bon Secours CA	4.03	3.25	4	3	2	2	2.50	4	3	2	2	2	2	3.00	4	2	3	2.67	1	3	4	4.00	4	Indispensable	
Warwick Fire B	2.82	1.75	1	2	2	2	1.00	-2	1	1	2	2	2	3.00	4	2	3	1.33	0	1	3	4.00	4	Indispensable	
Warwick Resc/B	2.88	2.25	2	2	2	3	1.00	-2	1	1	2	2	2	3.00	4	2	3	1.00	0	0	3	4.00	4	Indispensable	
<b>AVERAGE</b>	<b>B</b>	<b>3.40</b>					<b>1.47</b>							<b>3.00</b>				<b>2.47</b>				<b>3.60</b>			
<b>ECO / TECHNICAL CUSTOMERS</b>																									
CVS Pharm/C	2.67	1.50	2	0	0	4	1.33	1	0	1	2	2	2	3.00	4	2	3	0.00	0	0	0	4.00	4	Commercial br	
Alteva - War/C	2.64	0.75	1	0	-1	3	1.83	2	1	2	2	2	2	3.00	4	2	3	-0.33	0	-1	0	4.00	4	Commercial br	
Sinoco Gas S/C	2.74	1.00	1	0	0	3	1.50	1	1	1	2	2	2	3.00	4	2	3	0.67	0	0	2	4.00	4	Commercial br	
Commercial f/C	2.68	0.75	1	0	0	2	1.50	1	1	1	2	2	2	3.00	4	2	3	0.67	0	0	2	4.00	4	Commercial br	
<b>AVERAGE</b>	<b>C</b>	<b>2.68</b>					<b>1.54</b>							<b>3.00</b>				<b>0.25</b>				<b>4.00</b>			

# Appendix D: Optional Multi-Tiered Energy Services Model

The project team’s assessment of potential business models included consideration of alternative approaches, including a multi-tiered energy services model that may offer potential additional benefits for the community. Although the team’s analysis indicated that a multi-tiered energy services model was not necessary to meet the project’s goals, such a model may offer potential benefits that the community might wish to consider.

A. *Tiered energy services model:* Implementing the optional multi-tiered energy services model would enable Warwick stakeholders to guide and leverage investments to best support resiliency for critical services, while improving the community’s energy and environmental infrastructure and supporting ongoing economic development.

Task 2 design and modeling efforts focused on systems required to fulfill resilient energy service requirements for critical facilities in Warwick. Under a multi-tiered energy services model, these customers would be considered Tier 1 energy services customers. Detailed technical and commercial analysis of Tier 2 and Tier 3 requirements were deemed out of scope for the current phase of study. Implementing a three-tiered model would, however, expand the project’s strategic benefits and overall value proposition for the community, and thus merits review in this appendix and potential development in future study phases.

**Fig. 3.1-A: Three-Tiered Energy Services Model**

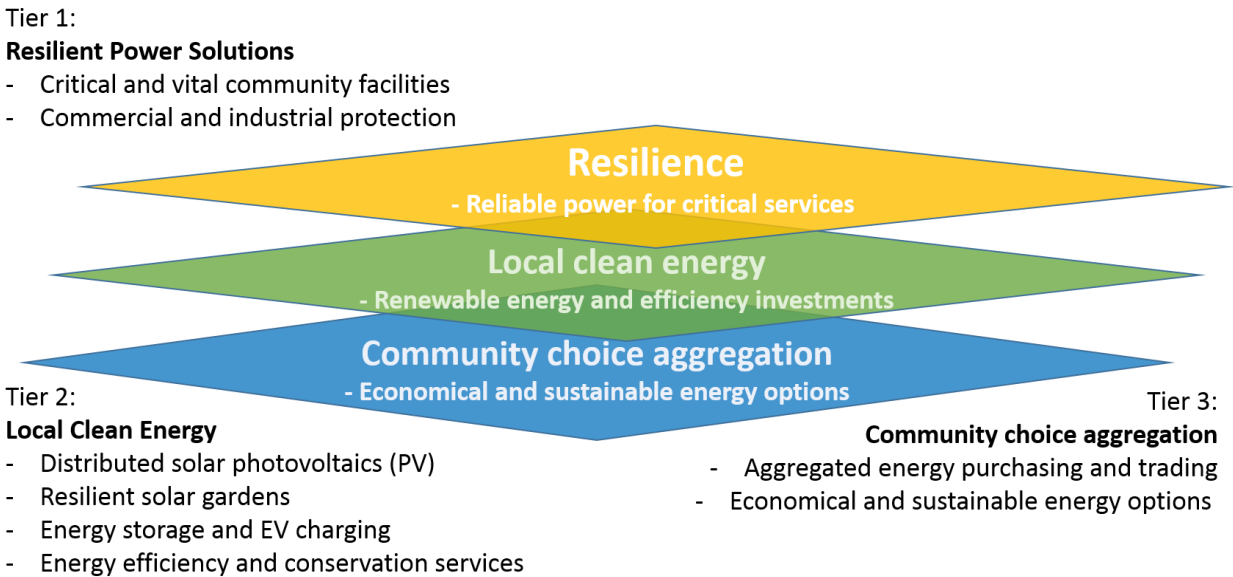

B. *Resiliency and synergistic benefits:* The three-tiered energy services structure is designed to strengthen community resiliency and produce value by meeting the energy needs of a broad range of customers in the Warwick area.

- a. Integrated Planning Benefits and Synergies: By providing a full range of energy service options for all Warwick customers, the microgrid would ensure that to the greatest extent possible, capital and other resources invested in DERs and energy management services are planned and deployed in ways that serve the community’s resiliency requirements. For example, prospective community solar gardens would be sited, designed, interconnected, and managed to ensure their energy output would be:
  - i. Available for resilient energy operations during utility outage events (if technically and economically feasible); and
  - ii. Structured and financed in ways that *support and do not impair* the microgrid’s ability to provide resilient energy services – as, for example, large net-metered solar arrays can do by displacing all of a critical facility’s energy purchases and thereby eliminating options for other DERs (including generation, storage, and demand) that are necessary to maintain resiliency. This phenomenon may be referred to as “vulnerability lock-in,” and it affected the Warwick Microgrid design substantially by making school district facilities not viable to receive resilient energy services from the proposed microgrid.
- b. Supporting Economics for Tier-1 Customers: Offering Tier 2 and Tier 3 services for all customers would strengthen the microgrid’s customer diversity, cash flow, and debt service coverage potential, supporting its ability to provide high-value Tier 1 Resiliency Services for critical customers. By using microgrid capabilities and resources to produce value for the most diverse possible range of customers, the microgrid would improve the relative proportions of customers with various service-cost and service-value profiles, strengthening the microgrid’s overall financial viability and therefore its capability to provide Tier 1 Resiliency Services for critical customers.
- c. Shared Services: Administrative and operational resources (staff, space, equipment, contracted services, etc.) that are required to provide Tier 1 Resiliency Services also would be used to provide Tier 2 and Tier 3 services. Accordingly incremental costs of providing and administrating services for more customers would decline as the number of additional customers increases.

Although this phase of analysis indicated that a multi-tiered energy services model was not necessary to meet project objectives, the team recommends considering such a model as part of Stage 2 development.

# Appendix E: Benefit-Cost Analysis

Industrial Economics Inc. Business-Cost Analysis summary follows.

# Benefit-Cost Analysis Summary Report

## Site 40 – Town of Warwick

---

### PROJECT OVERVIEW

As part of NYSERDA's NY Prize community microgrid competition, the Town of Warwick has proposed development of a microgrid that would serve the following facilities, grouped into ten nodes:

- Node 1 – Mount Alverno Center (an assisted living facility), Shervier Pavilion (a nursing home), Key Bank, St. Anthony's Hospital, Sunoco Gas Station, Warwick Village Hall, Craft Beer Cellar, Taco Hombre, Warwick Thai, Dunkin Donuts, Warwick Auto Body, Sensible Car Rental, Tokyo Plum House, Miller Ski & Sport, Chosun Taekwondo Academy, CVS, TD Bank, NAPA Auto Parts, Mr. Bill's Auto Repair, and Alteva-Warwick Valley Telecom;
- Node 2 – Warwick Fire District (Church Street);
- Node 3 – Warwick Town Hall and Warwick Police Station;
- Node 4 – River Street Pumping Station;
- Node 5 – Memorial Park Water Pump 2;
- Node 6 – Water Lane Water Filtration Plant;
- Node 7 – Warwick Fire District (South Street) and Warwick Rescue Squad;
- Node 8 – Orchard Street Pumping Station;
- Node 9 – State School Road Water Treatment Station; and
- Node 10 – DPW Garage/Fuel Depot.

The microgrid would draw on both existing and new gas-fired generators, diesel-fired generators, combined heat and power (CHP) systems, and solar capabilities. The existing sources, which include a photovoltaic (PV) array and seven gas- or diesel-fired emergency generators, have a total nameplate capacity of 1.2 MW. The new sources, which would include PV arrays at each node and several gas-fired CHP systems, would have a total nameplate capacity of 1.94 MW. The town anticipates that the existing PV array and the new distributed energy resources (DERs) would produce electricity for the grid during periods of normal operation, providing base load power; in contrast, the existing emergency generators would only operate in islanded mode. The system as designed would have sufficient generating capacity to meet average demand for electricity from the facilities on the microgrid during a major outage. The project's consultants also indicate that the system would have the capability of providing ancillary services to the grid.

To assist with completion of the project's NY Prize Stage 1 feasibility study, IEC conducted a screening-level analysis of the project's potential costs and benefits. This report describes the results of that analysis, which is based on the methodology outlined below.

## METHODOLOGY AND ASSUMPTIONS

In discussing the economic viability of microgrids, a common understanding of the basic concepts of benefit-cost analysis is essential. Chief among these are the following:

- *Costs* represent the value of resources consumed (or benefits forgone) in the production of a good or service.
- *Benefits* are impacts that have value to a firm, a household, or society in general.
- *Net benefits* are the difference between a project's benefits and costs.
- Both costs and benefits must be measured relative to a common *baseline* - for a microgrid, the "without project" scenario - that describes the conditions that would prevail absent a project's development. The BCA considers only those costs and benefits that are *incremental* to the baseline.

This analysis relies on an Excel-based spreadsheet model developed for NYSERDA to analyze the costs and benefits of developing microgrids in New York State. The model evaluates the economic viability of a microgrid based on the user's specification of project costs, the project's design and operating characteristics, and the facilities and services the project is designed to support. The model analyzes a discrete operating scenario specified by the user; it does not identify an optimal project design or operating strategy.

The BCA model is structured to analyze a project's costs and benefits over a 20-year operating period. The model applies conventional discounting techniques to calculate the present value of costs and benefits, employing an annual discount rate that the user specifies – in this case, seven percent.<sup>1</sup> It also calculates an annualized estimate of costs and benefits based on the anticipated engineering lifespan of the system's equipment. Once a project's cumulative benefits and costs have been adjusted to present values, the model calculates both the project's net benefits and the ratio of project benefits to project costs. The model also calculates the project's internal rate of return, which indicates the discount rate at which the project's costs and benefits would be equal. All monetized results are adjusted for inflation and expressed in 2014 dollars.

With respect to public expenditures, the model's purpose is to ensure that decisions to invest resources in a particular project are cost-effective; i.e., that the benefits of the investment to society will exceed its costs. Accordingly, the model examines impacts from the perspective of society as a whole and does not identify the distribution of costs and benefits among individual stakeholders (e.g., customers, utilities). When facing a choice among investments in multiple projects, the "societal cost test" guides the decision toward the investment that produces the greatest net benefit.

---

<sup>1</sup> The seven percent discount rate is consistent with the U.S. Office of Management and Budget's current estimate of the opportunity cost of capital for private investments. One exception to the use of this rate is the calculation of environmental damages. Following the New York Public Service Commission's (PSC) guidance for benefit-cost analysis, the model relies on temporal projections of the social cost of carbon (SCC), which were developed by the U.S. Environmental Protection Agency (EPA) using a three percent discount rate, to value CO<sub>2</sub> emissions. As the PSC notes, "The SCC is distinguishable from other measures because it operates over a very long time frame, justifying use of a low discount rate specific to its long term effects." The model also uses EPA's temporal projections of social damage values for SO<sub>2</sub>, NO<sub>x</sub>, and PM<sub>2.5</sub>, and therefore also applies a three percent discount rate to the calculation of damages associated with each of those pollutants. [See: State of New York Public Service Commission. Case 14-M-0101, Proceeding on Motion of the Commission in Regard to Reforming the Energy Vision. Order Establishing the Benefit Cost Analysis Framework. January 21, 2016.]

The BCA considers costs and benefits for two scenarios:

- Scenario 1: No major power outages over the assumed 20-year operating period (i.e., normal operating conditions only).
- Scenario 2: The average annual duration of major power outages required for project benefits to equal costs, if benefits do not exceed costs under Scenario 1.<sup>2</sup>

## RESULTS

Table 1 summarizes the estimated net benefits, benefit-cost ratios, and internal rates of return for the scenarios described above. The results indicate that even if there were no major power outages over the 20-year period analyzed (Scenario 1), the project’s benefits would exceed its costs by approximately 20%. As a result, the analysis does not evaluate Scenario 2. Consideration of Scenario 2 would further increase the project’s already positive benefit-cost ratio. The discussion that follows provides additional detail on these findings.

**Table 1. BCA Results (Assuming 7 Percent Discount Rate)**

ECONOMIC MEASURE	EXPECTED DURATION OF MAJOR POWER OUTAGES	
	SCENARIO 1: 0 DAYS/YEAR	SCENARIO 2
Net Benefits - Present Value	\$3,710,000	Not Evaluated
Benefit-Cost Ratio	1.2	Not Evaluated
Internal Rate of Return	10.1%	Not Evaluated

### Scenario 1

Figure 1 and Table 2 present the detailed results of the Scenario 1 analysis.

---

<sup>2</sup> The New York State Department of Public Service (DPS) requires utilities delivering electricity in New York State to collect and regularly submit information regarding electric service interruptions. The reporting system specifies 10 cause categories: major storms; tree contacts; overloads; operating errors; equipment failures; accidents; prearranged interruptions; customers equipment; lightning; and unknown (there are an additional seven cause codes used exclusively for Consolidated Edison’s underground network system). Reliability metrics can be calculated in two ways: including all outages, which indicates the actual experience of a utility’s customers; and excluding outages caused by major storms, which is more indicative of the frequency and duration of outages within the utility’s control. In estimating the reliability benefits of a microgrid, the BCA employs metrics that exclude outages caused by major storms. The BCA classifies outages caused by major storms or other events beyond a utility’s control as “major power outages,” and evaluates the benefits of avoiding such outages separately.

Figure 1. Present Value Results, Scenario 1 (No Major Power Outages; 7 Percent Discount Rate)

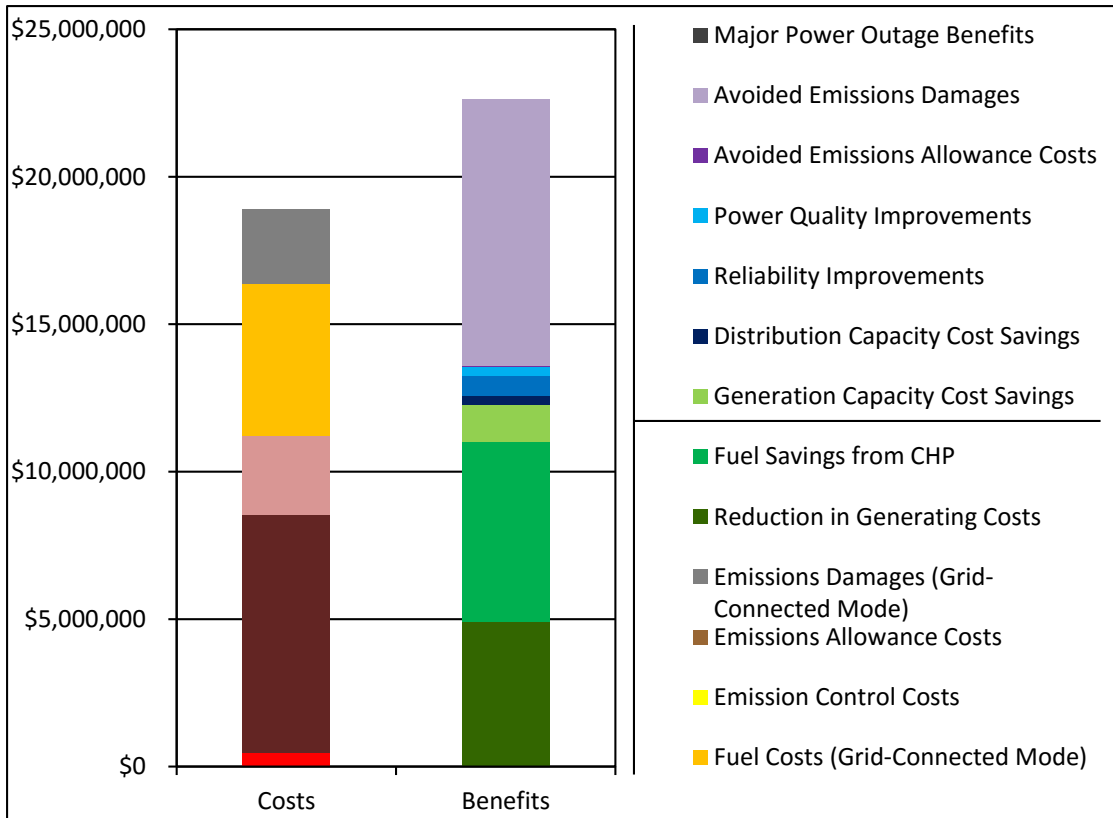



**Table 2. Detailed BCA Results, Scenario 1 (No Major Power Outages; 7 Percent Discount Rate)**

COST OR BENEFIT CATEGORY	PRESENT VALUE OVER 20 YEARS (2014\$)	ANNUALIZED VALUE (2014\$)
<b>Costs</b>		
Initial Design and Planning	\$475,000	\$41,900
Capital Investments	\$8,080,000	\$647,000
Fixed O&M	\$2,650,000	\$234,000
Variable O&M (Grid-Connected Mode)	\$0	\$0
Fuel (Grid-Connected Mode)	\$5,150,000	\$455,000
Emission Control	\$0	\$0
Emissions Allowances	\$0	\$0
Emissions Damages (Grid-Connected Mode)	\$2,540,000	\$166,000
<b>Total Costs</b>	<b>\$18,900,000</b>	
<b>Benefits</b>		
Reduction in Generating Costs	\$4,910,000	\$433,000
Fuel Savings from CHP	\$6,090,000	\$537,000
Generation Capacity Cost Savings	\$1,270,000	\$112,000
Distribution Capacity Cost Savings	\$294,000	\$25,900
Reliability Improvements	\$703,000	\$62,000
Power Quality Improvements	\$311,000	\$27,500
Avoided Emissions Allowance Costs	\$2,640	\$233
Avoided Emissions Damages	\$9,030,000	\$589,000
Major Power Outage Benefits	\$0	\$0
<b>Total Benefits</b>	<b>\$22,600,000</b>	
<b>Net Benefits</b>	<b>\$3,710,000</b>	
<b>Benefit/Cost Ratio</b>	<b>1.2</b>	
<b>Internal Rate of Return</b>	<b>10.1%</b>	

### Fixed Costs

The BCA relies on information provided by the project team to estimate the fixed costs of developing the microgrid. The project team's best estimate of initial design and planning costs is approximately \$475,000. The present value of the project's capital costs is estimated at approximately \$8.1 million, including costs associated with installing a microgrid control system; equipment for the substations that will be used to manage the microgrid; the IT infrastructure (communication cabling) for the microgrid; the new CHP systems; the new photovoltaic arrays; and the power lines needed to distribute the electricity the microgrid would generate. Operation and maintenance (O&M) of the entire system would be provided under fixed price service contracts, at an estimated annual cost of \$234,000. The present value of these O&M costs over a 20-year operating period is approximately \$2.7 million.

### Variable Costs

The most significant variable cost associated with the proposed project is the cost of fuel needed for operation of the system's primary generators. To characterize these costs, the BCA relies on estimates of fuel consumption provided by the project team and projections of fuel costs from New York's 2015

State Energy Plan (SEP), adjusted to reflect recent market prices.<sup>3</sup> The present value of the project's fuel costs over a 20-year operating period is estimated to be approximately \$5.2 million.

The analysis of variable costs also considers the environmental damages associated with pollutant emissions from the distributed energy resources that serve the microgrid, based on the operating scenario and emissions rates provided by the project team and the understanding that none of the system's generators would be subject to emissions allowance requirements. In this case, the damages attributable to emissions from the natural gas generators are estimated at approximately \$166,000 annually. The majority of these damages are attributable to the emission of CO<sub>2</sub>. Over a 20-year operating period, the present value of emissions damages is estimated at approximately \$2.5 million.

### **Avoided Costs**

The development and operation of a microgrid may avoid or reduce a number of costs that otherwise would be incurred. These include generating cost savings resulting from a reduction in demand for electricity from bulk energy suppliers. The BCA estimates the present value of these savings over a 20-year operating period to be approximately \$4.9 million. This estimate assumes the microgrid provides base load power – consistent with the operating profile upon which the analysis is based – and takes into account not only the electricity that the microgrid's distributed energy resources would produce, but also an anticipated reduction in annual electricity use at the facilities the microgrid would serve.<sup>4</sup> Cost savings would also result from reductions in fuel consumption for space heating purposes. The BCA estimates the present value of these savings over a 20-year operating period to be approximately \$6.1 million. The reduction in demand for electricity from bulk energy suppliers and the fuel efficiency of the new CHP systems would also reduce emissions of CO<sub>2</sub>, SO<sub>2</sub>, NO<sub>x</sub>, and PM from these sources, yielding emissions allowance cost savings with a present value of approximately \$2,600 and avoided emissions damages with a present value of approximately \$9.0 million.<sup>5</sup>

In addition to the savings noted above, development of a microgrid could yield cost savings by avoiding or deferring the need to invest in expansion of the conventional grid's energy generation or distribution capacity.<sup>6</sup> The analysis estimates the impact on available generating capacity to be approximately 0.94 MW per year, based primarily on estimates of output from the new CHP units. In addition, the project team expects development of the microgrid to reduce the conventional grid's demand for generating capacity by an additional 0.17 MW as a result of new demand response capabilities. Based on these figures, the BCA estimates the present value of the project's generating capacity benefits to be approximately \$1.3 million over a 20-year operating period. The present value of the project's potential distribution capacity benefits is estimated to be approximately \$294,000.

---

<sup>3</sup> The model adjusts the State Energy Plan's natural gas and diesel price projections using fuel-specific multipliers calculated based on the average commercial natural gas price in New York State in October 2015 (the most recent month for which data were available) and the average West Texas Intermediate price of crude oil in 2015, as reported by the Energy Information Administration. The model applies the same price multiplier in each year of the analysis.

<sup>4</sup> The project's consultants anticipate an annual reduction in electricity consumption of approximately four percent due to energy efficiency upgrades included with the microgrid.

<sup>5</sup> Following the New York Public Service Commission's (PSC) guidance for benefit-cost analysis, the model values emissions of CO<sub>2</sub> using the social cost of carbon (SCC) developed by the U.S. Environmental Protection Agency (EPA). [See: State of New York Public Service Commission. Case 14-M-0101, Proceeding on Motion of the Commission in Regard to Reforming the Energy Vision. Order Establishing the Benefit Cost Analysis Framework. January 21, 2016.] Because emissions of SO<sub>2</sub> and NO<sub>x</sub> from bulk energy suppliers are capped and subject to emissions allowance requirements in New York, the model values these emissions based on projected allowance prices for each pollutant.

<sup>6</sup> Impacts to transmission capacity are implicitly incorporated into the model's estimates of avoided generation costs and generation capacity cost savings. As estimated by NYISO, generation costs and generating capacity costs vary by location to reflect costs imposed by location-specific transmission constraints.

The project team has indicated that the proposed microgrid would be designed to provide ancillary services to the New York Independent System Operator (NYISO). Whether NYISO would select the project to provide these services depends on NYISO's requirements and the ability of the project to provide support at a cost lower than that of alternative sources. Based on discussions with NYISO, it is our understanding that the market for ancillary services is highly competitive, and that projects of this type would have a relatively small chance of being selected to provide support to the grid. In light of this consideration, the analysis does not attempt to quantify the potential benefits of providing such services.

### Reliability Benefits

An additional benefit of the proposed microgrid would be to reduce customers' susceptibility to power outages by enabling a seamless transition from grid-connected mode to islanded mode. The analysis estimates that development of a microgrid would yield reliability benefits of approximately \$62,000 per year, with a present value of approximately \$703,000 over a 20-year operating period. This estimate is calculated using the U.S. Department of Energy's Interruption Cost Estimate (ICE) Calculator, and is based on the following indicators of the likelihood and average duration of outages in the service area:<sup>7</sup>

- System Average Interruption Frequency Index (SAIFI) – 1.08 events per year.
- Customer Average Interruption Duration Index (CAIDI) – 97.2 minutes.<sup>8</sup>

The estimate takes into account the number of small and large commercial or industrial customers the project would serve; the distribution of these customers by economic sector; average annual electricity usage per customer, as provided by the project team; and the prevalence of backup generation among these customers. It also takes into account the variable costs of operating existing backup generators, both in the baseline and as an integrated component of a microgrid. Under baseline conditions, the analysis assumes a 15 percent failure rate for backup generators.<sup>9</sup> It assumes that establishment of a microgrid would reduce the rate of failure to near zero.

It is important to note that the analysis of reliability benefits assumes that development of a microgrid would insulate the facilities the project would serve from outages of the type captured in SAIFI and CAIDI values. The distribution network within the microgrid is unlikely to be wholly invulnerable to such interruptions in service. All else equal, this assumption will lead the BCA to overstate the reliability benefits the project would provide.

### Power Quality Benefits

The power quality benefits of a microgrid may include reductions in the frequency of voltage sags and swells or reductions in the frequency of momentary outages (i.e., outages of less than five minutes, which are not captured in the reliability indices described above). The analysis of power quality benefits relies on the project team's best estimate of the number of power quality events that development of the microgrid would avoid each year. The Warwick project team estimates that the microgrid would help the facilities it serves avoid an average of approximately 1.7 power quality events per year. The model estimates the present value of this benefit to be approximately \$311,000 over a 20-year operating period.

---

<sup>7</sup> [www.icecalculator.com](http://www.icecalculator.com).

<sup>8</sup> The analysis is based on DPS's reported 2014 SAIFI and CAIDI values for Orange & Rockland.

<sup>9</sup> <http://www.businessweek.com/articles/2012-12-04/how-to-keep-a-generator-running-when-you-lose-power#p1>.

## **Summary**

The analysis of Scenario 1 yields a benefit/cost ratio of 1.2; i.e., the estimate of project benefits exceeds the project costs by approximately 20%. Accordingly, the analysis does not consider the potential of the microgrid to mitigate the impact of major power outages in Scenario 2. Consideration of such benefits would further increase the net benefits of the project's development.